



TOYOTA
CELICA

F OWNERS' MANUAL

FOREWORD

We at Toyota thank you for selecting the Celica, and heartily welcome you into the Toyota Family!

The Toyota Celica is a product of the finest engineering skills and techniques available. We have prepared this manual to acquaint you with the vehicle, and to serve as a guide for its proper handling and safe driving. To help assure trouble-free operation, completely familiarize yourself with the contents of this manual at once.

Descriptions in this manual are based on the left-hand drive ST model. When the LT or GT model has any different factor from the ST model, a notation is attached. Where there is no notation, the explanation refers to all models.

Toyota provides you with a complete dealer servicing network in your country. This is to provide quality service and assure pleasant motoring to all Toyota enthusiasts. In accordance with the terms and conditions described in the Toyota Warranty Booklet, your Celica will be properly serviced in the event of trouble during the warranty period.

Once again, thank you for selecting the Celica, and welcome to Toyota!

TOYOTA MOTOR SALES CO., LTD.

All information and specifications contained in this manual were the most up-to-date at the time of printing, and we reserve the right to make changes at any time without notice.

Contents

HOW THE INSTRUMENTS AND CONTROLS WORK	
Instrument Panel	4
Driving Comfort and Safety	13
Convenience Features and Other Controls	19
STARTING AND DRIVING YOUR CAR	
How to Start the Engine	33
How to Drive with a Manual Transmission	36
How to Drive with an Automatic Transmission	37
Driving Hints	40
MAINTAINING YOUR CAR	
Scheduled Maintenance	48
Non-scheduled Maintenance	50
Maintenance You Can Do	51
FUEL, LUBRICANT AND SPECIFICATIONS	76
INDEX	83

HOW THE INSTRUMENTS AND CONTROLS WORK

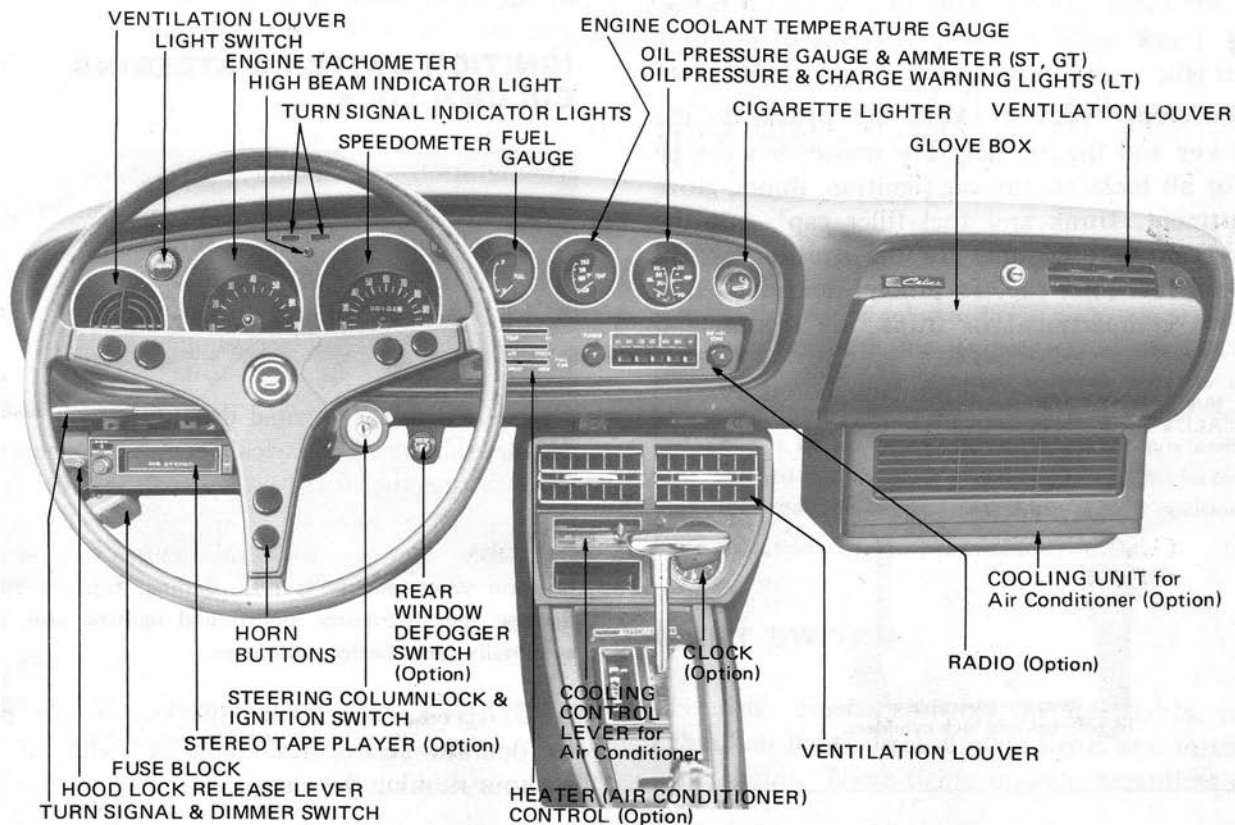

Instrument Panel

KEYS

Two different types of keys are provided: the master key and the sub-key. The master key can be used for all locks on the car (ignition, doors, glove compartment, trunk and fuel filler cap), but the sub-key can be used only for the ignition switch, doors and fuel filler cap. To protect items locked in the glove compartment or trunk, we recommend

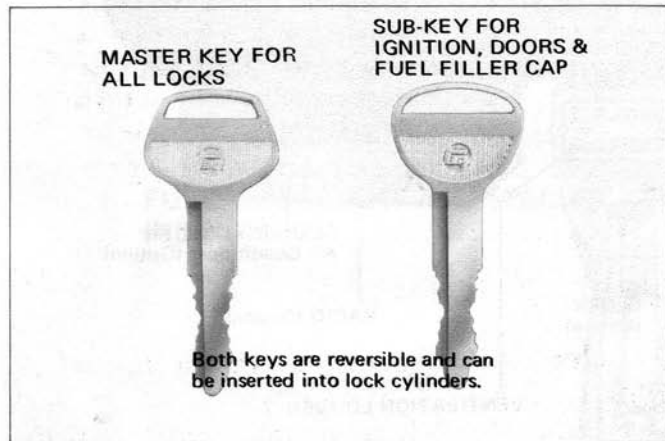

that you leave the sub-key with the car when you are leaving the car for parking or servicing.

IGNITION SWITCH & STEERING COLUMN LOCK

The ignition switch and steering column lock are combined in a single unit. The key can be turned to four positions as marked on the switch:

START.....Turn the key to this position to start the engine.

ON.....This is the normal driving position, with the engine on and all electrical accessories operative. To stop the engine, turn the key to the ACC position.

CAUTION: Do not leave the ignition key in the ON position when engine is not running. Current flow may damage the distributor points and ignition coil, and will eventually cause battery discharge.

ACC (Accessories).....Turn the key to this position to operate accessories (such as radio or stereo) without running the engine.

LOCK.....Press the locking button to turn the key to the LOCK position.

The key can be removed only when it is in this position. Removing the key locks the steering column for added theft protection.

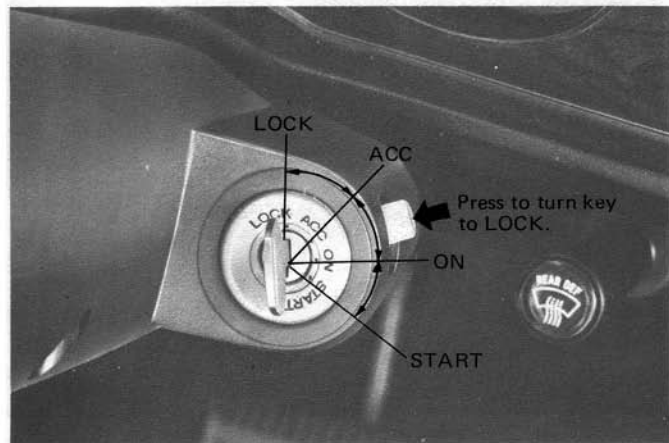

WARNING: Never turn the key to LOCK position while the car is moving.

Unlocking

To unlock the steering wheel, insert the key in the ignition switch and turn the key from the LOCK position to the ACC position. If the key is hard to turn, gently move the steering wheel slightly each way while turning the key until it moves off the LOCK position.

WARNING: To prevent the accidental locking of the steering column, do not push, tow or coast your car with the ignition key in the LOCK position. If it is necessary to push your car to start the engine, make certain that the ignition key is in the ON position. If your car is being pushed or towed for any other reason, make certain that the ignition key is in the ACC position.

LIGHT SWITCH

The light switch controls the headlights, parking lights, tail lights, license plate lights and instrument panel lights. These lights operate regardless of the

ignition switch. In ST and GT models, the switch knobs such as for light switch, wiper and washer switch and hazard warning light switch glow when the light switch is turned on.

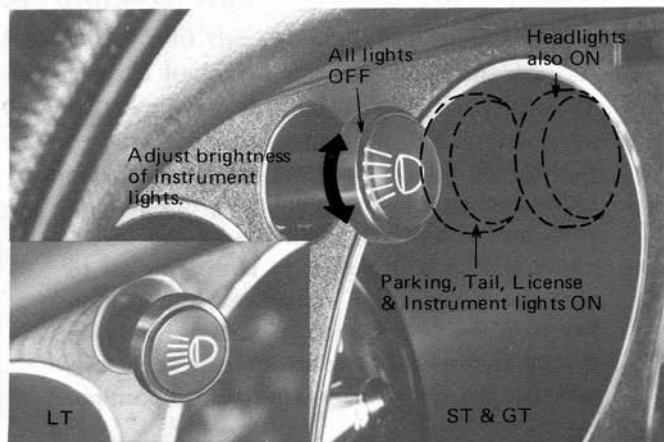

TURN SIGNAL & DIMMER SWITCH

The turn signals operate only when the ignition switch is in the ON position, but the dimmer functions regardless of the position of the ignition switch.

Operation of turn signal:

Move the lever upward to signal a right turn and move the lever downward to signal a left turn. (In right-hand drive car, the operating directions of the lever are opposite to those shown in the illustration.)

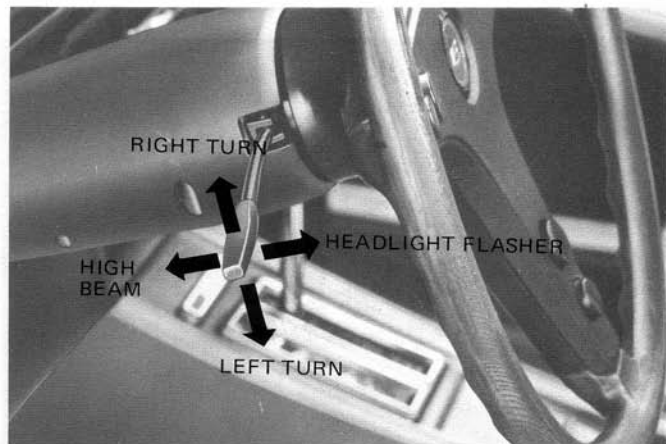

The green indicator light on the instrument panel will flash intermittently, indicating that the turn signal lights are operating properly. The turn signal switch is normally cancelled when the steering wheel returns after completing a turn. However, manual

cancelling may be required after making a gradual turn, such as when changing lanes.

For changing headlight beams:

Move the lever toward you for low beam and away for high beam. When the headlights are on high beam, a purple indicator light on the instrument panel will light.

To operate headlight flasher, pull turn signal & dimmer switch lever from low beam position toward steering wheel. Headlights will remain on high beam as long as the lever is held in pulled position. The headlight flasher operates regardless of the lighting switch or ignition switch position.

WINDSHIELD WIPER & WASHER SWITCH

The windshield wipers and washer can be operated only when the ignition switch is in the ON position. The windshield wipers operate at two different speeds so that the proper speed can be selected in accordance with the rainfall and vehicle speed. The windshield wipers are self-parking type. They will automatically return to their original position and stop when the switch is pushed in to the OFF position.

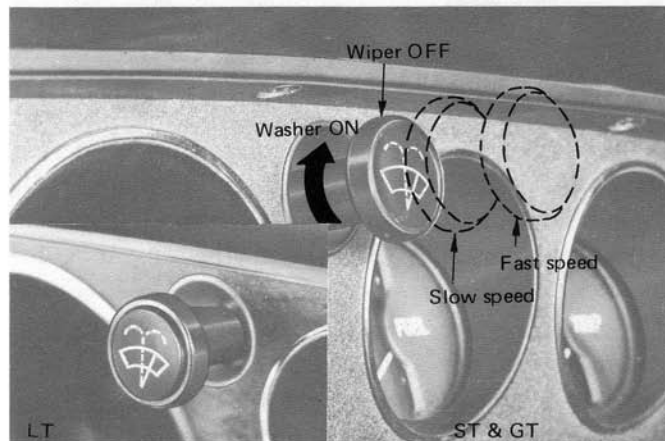

The windshield washer will operate with the windshield wiper either on or off provided the ignition switch is in the ON position.

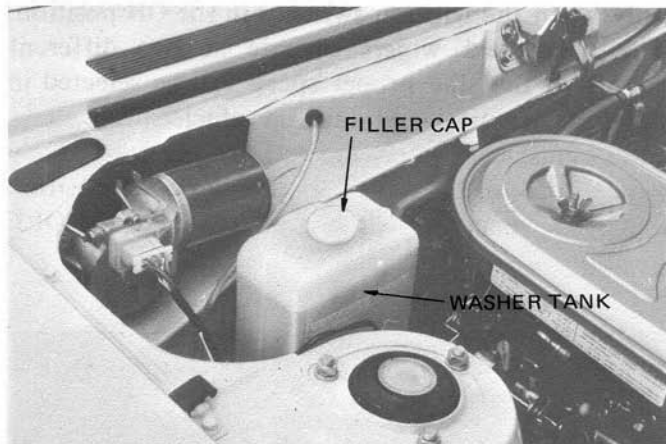

If the washer fluid stops squirting, do not operate the washer pump. Check to see whether there is still washer fluid in the tank, and fill the tank if it is empty. The washer tank is in the engine compartment.

Use of a commercial windshield washer solution is recommended for effectively cleaning the windshield; when not available, plain water may also be used. However, do not use water in freezing weather,

and never use anti-freeze solution because it will damage plated and painted surfaces of the body.

HAZARD WARNING LIGHT SWITCH

When the knob of the hazard warning light switch is pulled out, all four turn signal lights will blink at the same time as an emergency warning to other motorists, and both turn signal indicator lights on the instrument panel will flash simultaneously. The hazard warning lights operate regardless of the ignition switch, and even without the key.

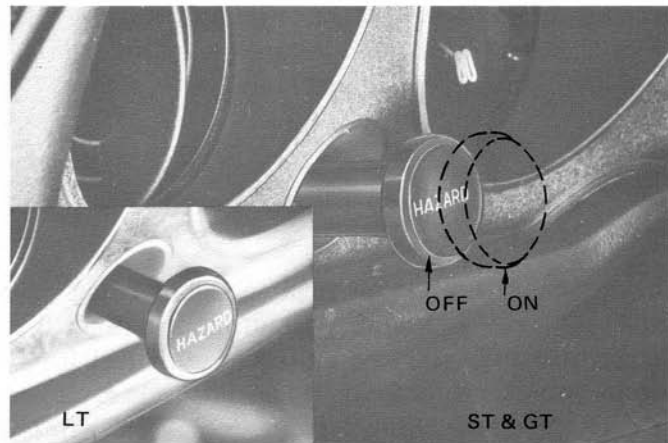

SPEEDOMETER

The forward speed of the vehicle is indicated in kilometers or miles per hour.

The speedometer incorporates two other meters:

1. Odometer: The odometer registers the total distance the vehicle has traveled; it acts as a guide to determine periodic maintenance.
2. Trip meter: If the trip meter is reset to 000.0 before setting out on a trip, the distance traveled can be determined. Turn the knob clockwise to reset.

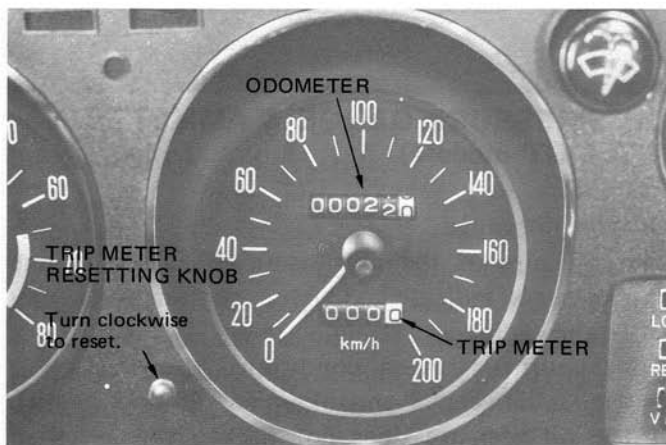

TACHOMETER

The tachometer indicates the engine speed in rpm (revolutions per minute). To obtain the actual rpm value, add two zeros to the scale reading. Thus, a reading of 40 becomes 4,000 rpm.

CAUTION: The scale beyond 6,500 rpm (7,000 rpm for GT) is marked in red. Operating the engine in this zone can result in serious damage, including engine destruction.

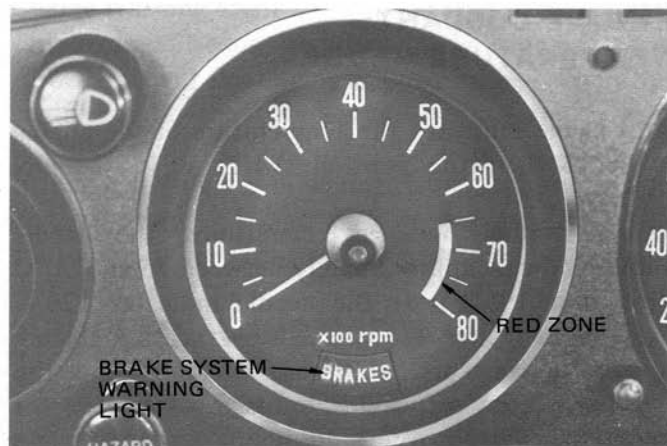

FUEL GAUGE

The fuel gauge indicates the quantity of gasoline in the tank. Read the gauge with the ignition switch ON and with the vehicle on level ground either parked or travelling at a constant speed.

The letter F stands for FULL and E for EMPTY. When the needle approaches the E mark, it is the time to refuel. Make it a habit to refuel before the fuel level drops to the critical value.

ENGINE COOLANT TEMPERATURE GAUGE

This gauge indicates the temperature of the engine coolant when the ignition switch is in the ON position.

Under normal operating conditions, the needle should indicate approximately between 75 and 90°C (165 and 195°F). If the needle indicates 120°C (250°F) or higher, the engine is overheating. If such a condition occurs, stop your car and allow the engine to cool off. Refer to page 44 and 53 for details.

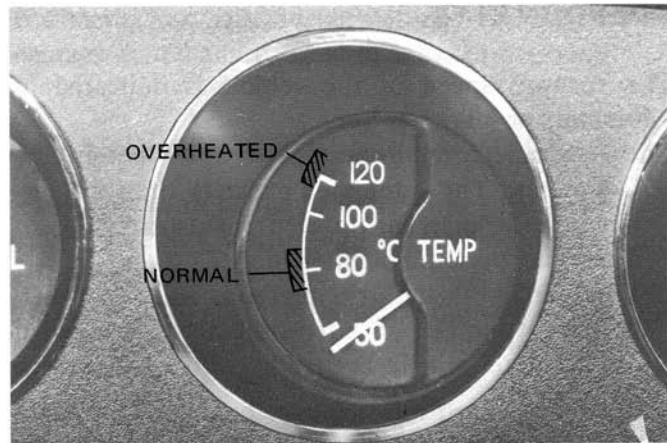

OIL PRESSURE GAUGE & AMMETER (ST & GT models)

Oil pressure gauge

The pressure of the lubricating oil in the engine crankcase is indicated. This gauge functions only when the engine is running.

Under normal driving conditions, the pressure is generally between 3 and 5kg/cm² (40 and 70 psi). If the oil pressure does not rise to the specified

value, stop the engine immediately and check the engine oil level, and check for leakage of oil. See

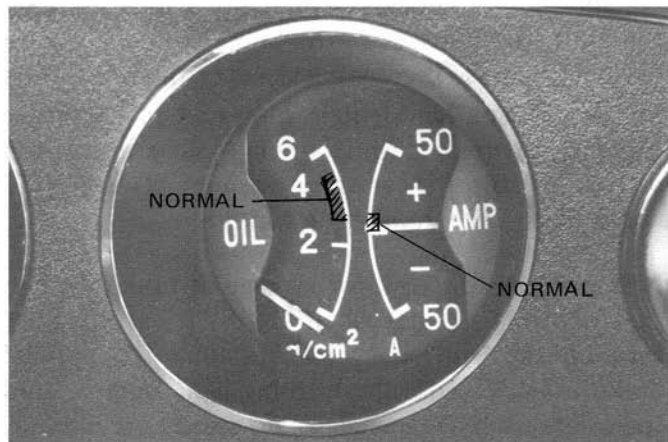

page 45 and 51 for details. DO NOT continue driving under low oil pressure.

Ammeter

This meter indicates whether the battery is being charged or is discharging. Under normal driving conditions, the needle will indicate slight charging. If the needle continues to indicate discharging when driving, stop the engine and refer to page 45 and 57 for further information.

OIL PRESSURE & CHARGE WARNING LIGHTS (LT model)

Oil Pressure Warning Light

The light will be on when the ignition switch is turned on and the engine is not running, and the light should go off after the engine is started.

If this light flickers now and then or remains on while driving, immediately stop the engine and check the level of lubricant; and check for any leakage of oil. See page 45 and 51 for details. DO NOT continue driving under low oil pressure.

Charge Warning Light

This light will come on when the ignition switch is turned on and the engine is not running. When the engine starts, the light should go out and remain out, indicating that the alternator is generating.

If this light remains on while driving, stop the engine and see page 45 and 57 for details. DO NOT continue driving with the charge warning light lit up.

TURN SIGNAL INDICATOR LIGHT

These lights indicate that the front and rear turn signal lights are functioning properly when the turn

signal switch is operated.

If the indicator light remains on, it indicates that the bulb of either front or rear turn signal lights has failed. If the indicator light fails to flash, either the fuse or the bulb of indicator light has failed. See page 71 and 74 for instructions for replacing turn signal light bulb and fuse.

HEADLIGHT HIGH BEAM INDICATOR LIGHT

This light indicates that the headlights are on high beam. Change to low beam to decrease the glare when following or passing another vehicle, or for oncoming traffic.

BRAKE SYSTEM WARNING LIGHT

This light has two different functions as described below. It is operational when the key is turned to the ON position.

Function as parking brake warning light: The light glows when the parking brake is set and goes out when the parking brake lever is completely released. Be sure that this light is off before driving.

Function as brake system warning light (only for the car equipped with an optional dual circuit brake system and GT model): This light warns you that the hydraulic pressure in the brake system does not develop, because there is a leakage of the brake fluid in the system. If this light glows when the brake pedal is depressed while driving, slow down and manage to stop the car as soon as possible. **DO NOT** continue to drive under such conditions.

It is possible to check for leakage of brake fluid in the following manner when the car is parked. First turn on the ignition switch and pull the parking brake lever to cause the warning light to glow, and then depress brake pedal. If no leakage is present, the warning light will go off and will not glow while the brake pedal is kept depressed. If the warning light does not go off when the brake pedal is depressed, it is an indication of a leak in the brake system. **DO NOT** drive if there is the slightest possibility that brake fluid is leaking.

CAUTION: Even if no fault is discovered in the above inspection, it is necessary to visually check the level of brake fluid in the master cylinder reservoir. See page 59 for inspection procedure.

Driving Comfort and Safety

DOOR LOCKS

How to Lock and Unlock with Key

Insert the key into either door lock cylinder and turn towards the rear of the car to lock, and in the opposite direction to unlock.

How to Lock from the Exterior without Key

Push in the door lock button and then close the door with the outside door handle held in pulled out position.

Care should be taken not to leave the key in the interior when closing the doors in this manner.

How to Lock from the Interior

Push in the door lock button after closing the door. Then the door cannot be opened by either outside or inside door handle.

Always lock the doors from the interior when driving.

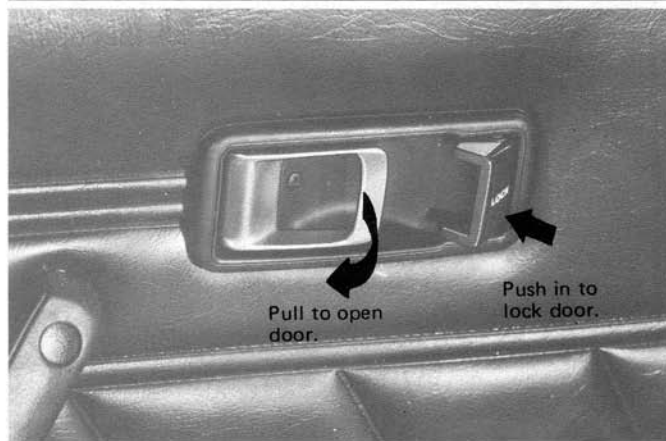
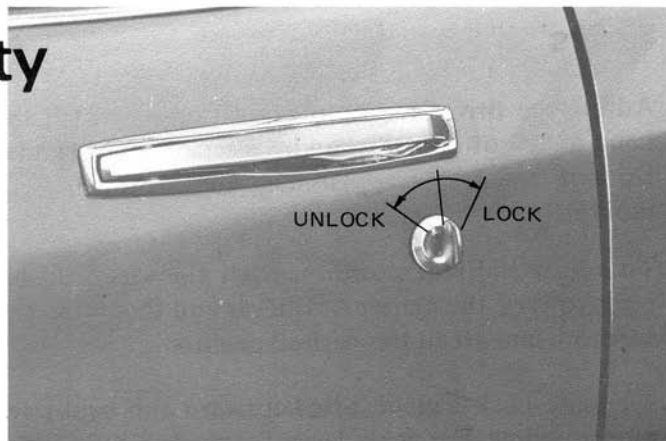

SEATS

Adjust the driver's seat to a position where all the hand and foot controls can be reached comfortably. Do not make seat adjustment while the car is in motion.

To adjust the seat position, push the seat adjuster lever toward the center of the car and then slide the seat fore-and-aft to the desired position.

The seat back can be tilted forward and backward while pulling the lock lever forward. To lock the seat back, release the lock lever at the desired position.

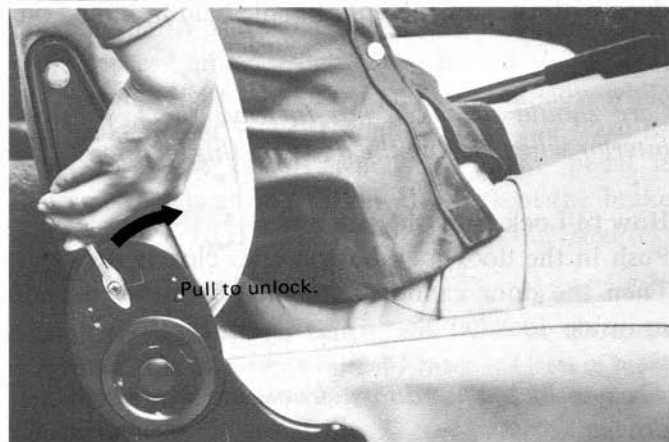
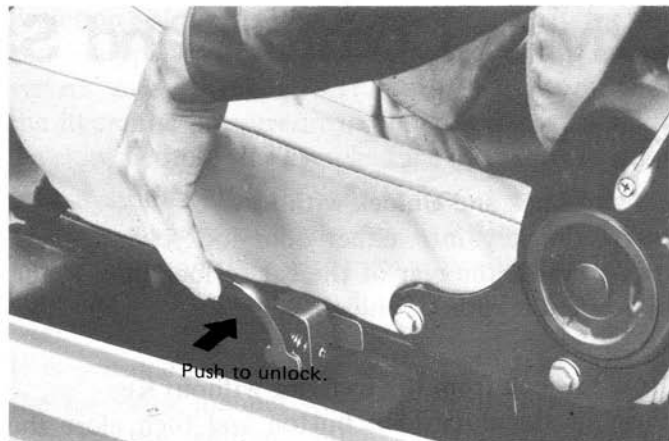

SEAT BELTS (Option)

To fasten the seat belt, first adjust the seat to the most suitable position for driving and then fasten the belt in the following manner.

1. Pull the outboard belt out of the retractor and fit the connector pin of the shoulder belt into the tongue of the outboard belt. Make sure that neither belt is twisted.
2. Fully extend the outboard belt from the retractor and then insert its tongue into the buckle of the inboard belt until there is an audible snap. Then adjust the length of the inboard belt so that the belt fits snugly around your hips as low as possible. To shorten the length of the inboard belt, hold the buckle at right angles to the belt and pull the end of the inboard belt.
3. To adjust the length of the shoulder belt, hold the connector at right angles to the shoulder belt and pull the connector to lengthen, or pull the upper belt to shorten as shown.

The shoulder belt is properly adjusted when the

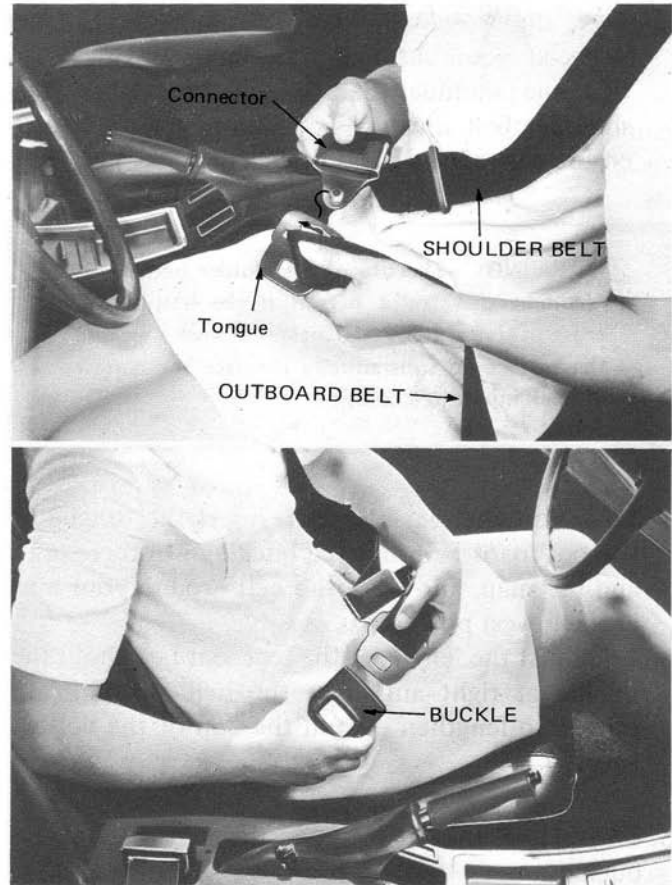

slack allows enough room for your clenched fist between your chest and the belt. Make certain that the shoulder belt is not too tight. (The shoulder belt must be adjusted in such a way to ensure easy access of all driving controls.)

WARNING: The use of a shoulder belt is not recommended for a person if the belt would cross over the body too near the neck, because the belt could substantially increase the danger of neck injury in a collision.

4. To fasten the rear seat belt, insert the tongue of the outboard belt into the buckle until there is an audible snap, and wear the belt around your hips in the lowest position as possible.

To adjust the length of the rear seat belt, hold the buckle at right angles to the belt and pull the buckle to lengthen or pull the end of the belt to shorten.

5. To release the belt, press the button on the buckle.

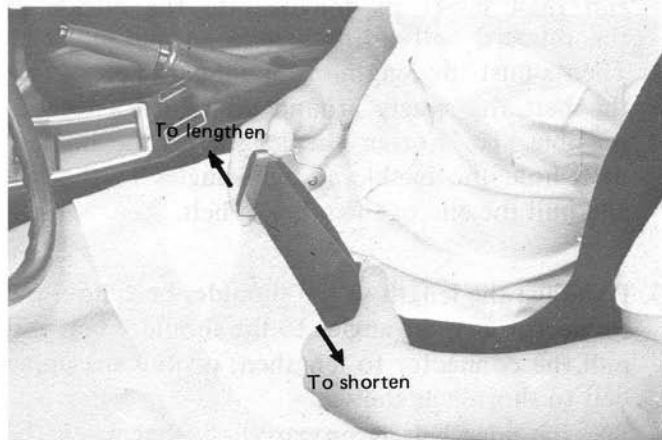
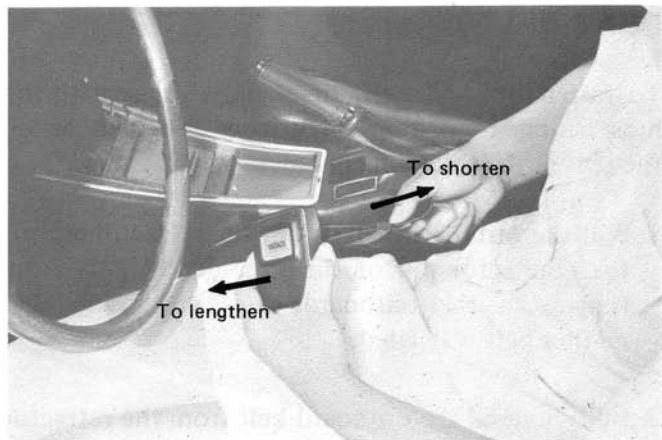

- 1. The outboard belt must be completely pulled out of the retractor.*
- 2. Never use the same belt for more than one person at a time.*
- 3. The buckle of the lap belt can be stored in the buckle holder located between the front seats. Depress the release button to remove it from the holder.*
- 4. When not in use, store the shoulder belt in the overhead retainer as shown.*



PARKING BRAKE

When the parking brake lever is set, the rear wheels are mechanically locked and the warning light will glow if the ignition switch is in the ON position.

Make sure that the warning light is off before starting.

Always apply the parking brake whenever you park your car.

CAUTION: If the service brake becomes inoperative when driving, it is possible to use the parking brake for an emergency stop.

To release the parking brake, depress the button in the tip of the lever and lower it with the button kept depressed.

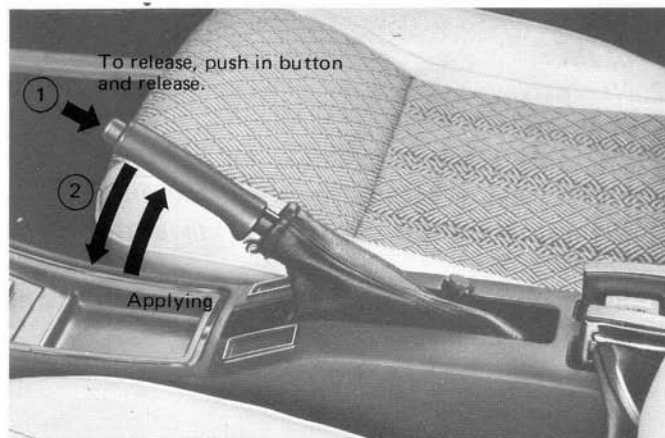

Convenience Features and Other Controls

REARVIEW MIRRORS

Outside and inside rear view mirrors are an important means of observing the traffic conditions behind you. Adjust them after making seat adjustment so that proper rear view can be obtained. Both rear view mirrors are swivel mounted and can easily be adjusted by hand.

Non-glare type inside mirror for ST and GT models reduces glare of vehicles following by simply switching the lever located at the bottom of the mirror.

GLOVE BOX

To open the locked glove box door, insert the master key into key slot, turn clockwise and depress the button.

If the lighting switch is pulled out to either the 1st or 2nd-position, the glove box light will come on when the glove box door is opened.

An inspection light socket is located in the glove box.

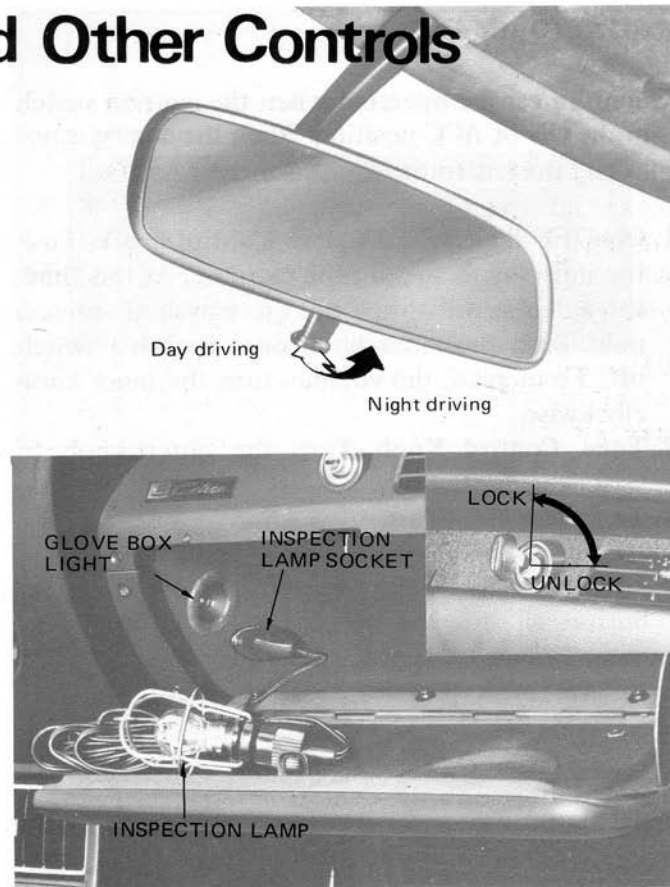

RADIO (Option)

The radio can be operated when the ignition switch is in the ON or ACC position. When the engine is not running, the key must be positioned at ACC.

1. **ON-OFF Switch & Volume Control Knob**—Push the inner knob to turn the radio on. At this time, the antenna will spring out one length of antenna pole. Push the inner knob once again to switch off. To increase the volume, turn the inner knob clockwise.
2. **Tone Control Knob**—Turn the outer knob to select the desired tone.
3. **Tuning Knob**—Turn the knob either way to receive a station manually.
4. **Push Button**—To set a push button, pull the button all the way out, turn the knob (3) to obtain a desired station, then push the button all the way in. Repeat for each push button.
5. **FM-AM Selecting knob**—To receive FM broadcasts, turn the knob clockwise. To reswitch to AM station, turn the knob counterclockwise.

AM Radio

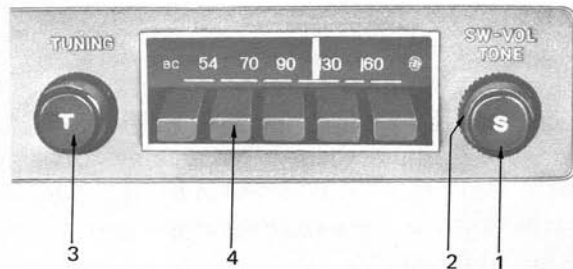

AM-FM Radio

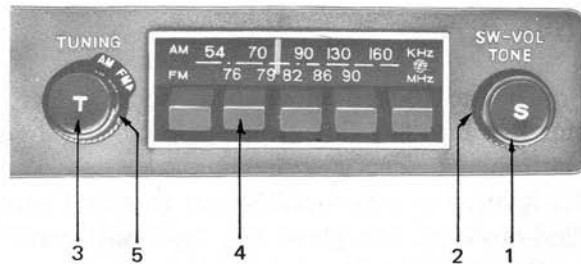

STEREO TAPE PLAYER (Option)

The stereo tape player can be operated when the ignition switch is in the ON or ACC position. When the engine is not running, the key must be positioned at ACC.

To play, insert the cartridge with label side up into the slot. This will automatically turn on the player.

1. **Balancer Dial**—To balance the speakers, keep the white line of the dial at the center.
2. **Volume Control Knob**—To increase the volume, turn the inner knob clockwise.
3. **Tone Control Knob**—Turn the outer knob to select the desired tone.
4. **Program & Ejector Button and Channel Indicator**—To change the channel, push the button down.

To change the cartridge, push the button in. The cartridge will spring out slightly, then remove it. At this time, the player will be automatically turned off.

The channel indicator light in the button glows when the player is in operation.

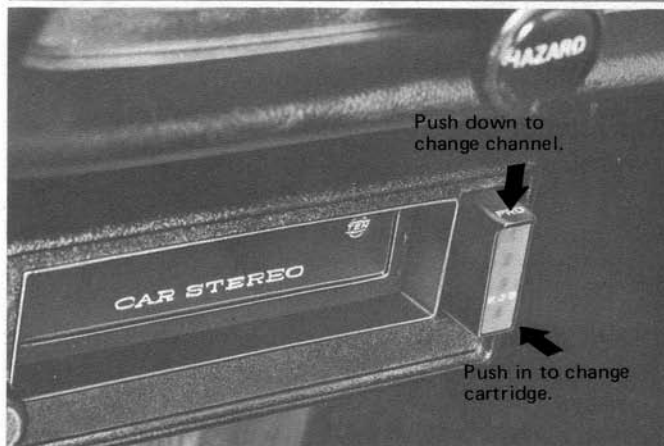
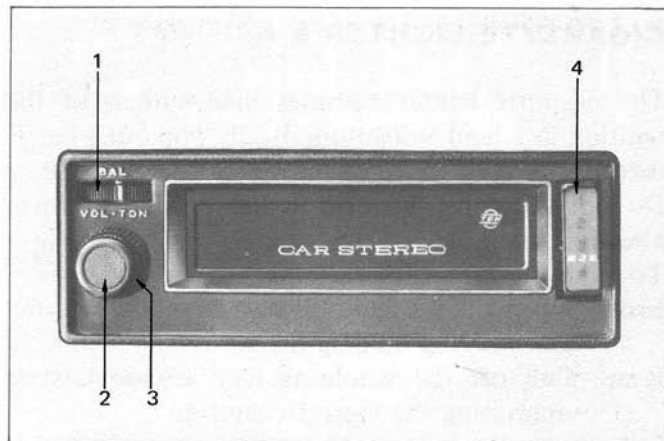

CIGARETTE LIGHTER & ASHTRAY

The cigarette lighter operates independent of the ignition key, and will automatically pop out when it is ready for use.

Do not keep the cigarette lighter pressed in when already heated.

To remove ashtrays for cleaning:

Front—Open the lid and pull out the entire ashtray assembly by holding the cigarette snuffer.

Rear —Pull off the whole ashtray assembly while depressing the cigarette snuffer.

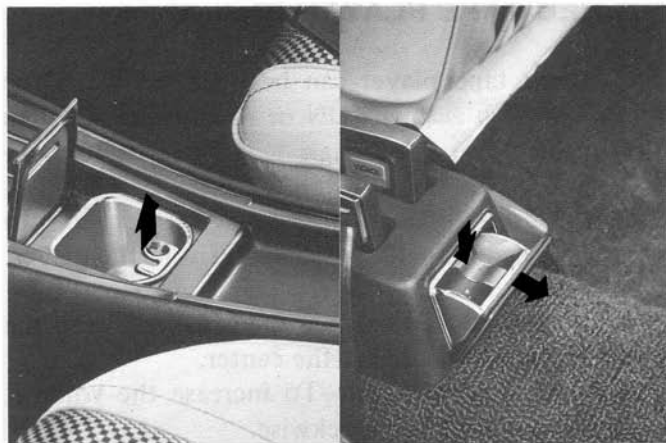

INTERIOR LIGHT

The interior light switch has three positions for easy control.

ON position: The light stays on with doors opened or closed regardless of the position of the ignition key in the switch.

DOOR position: The light comes on when any door is opened and goes off when all the doors are closed.

OFF position: The light remains off.

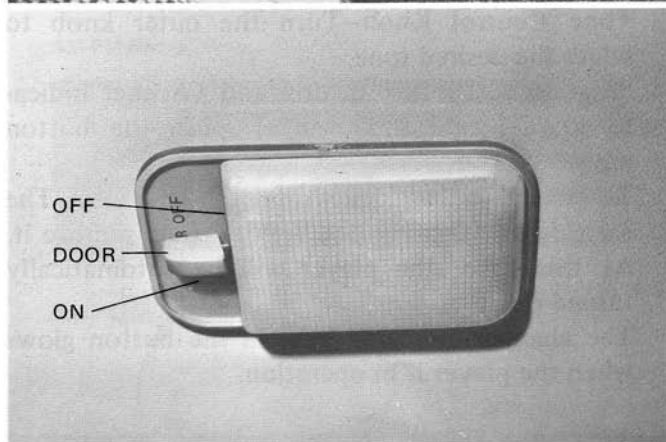

CLOCK (Option)

To set the clock hands, pull the knob and turn it clockwise to advance and counterclockwise to retard.

Turn the knob in either direction without pulling to set the time ring.

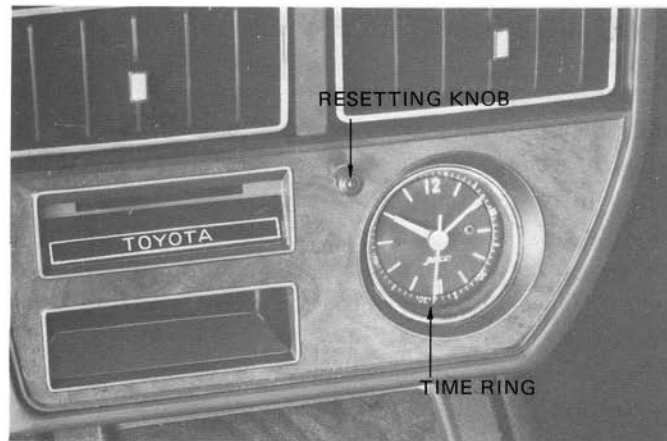

REAR WINDOW DEFOGGER (Option)

To operate the rear window defogger, pull out the defogger switch knob while the engine is running. The switch knob glows red when the defogger is in operation. Turn off the switch after the rear window clears up to prevent unnecessary electrical drain from the battery. Since heater wires are printed on the inside surface of rear window glass, refrain from rubbing off or scratching the printed wires with a hard or sharp article.

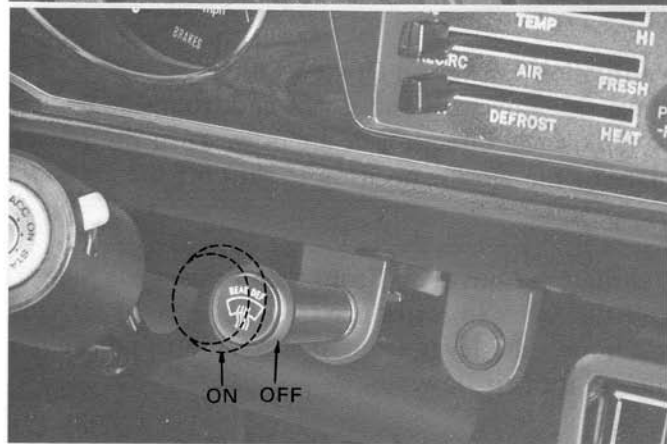

VENTILATION SYSTEM

Center Ventilation Louver

Set the air intake control lever at FRESH and air flow direction control lever at VENT, then the fresh air is introduced into the interior while the car is moving. Refer to page 27 for Boost Ventilation. Entry of fresh air is stopped when the air intake control lever is moved to RECIRC (Recirculate) position.

Move the levers up and down and from side to side to adjust the direction of air flow. (ST & GT models)

Ventilation Louver on Driver's Side

Move the louver up and down and from side to side to adjust the direction of air flow. Turn the louver plate to the closing position to shut off the air flow.

Ventilation Louver on Front Seat Passenger's Side

Pull the knob to introduce fresh air into car interior and move the lever from side to side to adjust the direction of air flow.

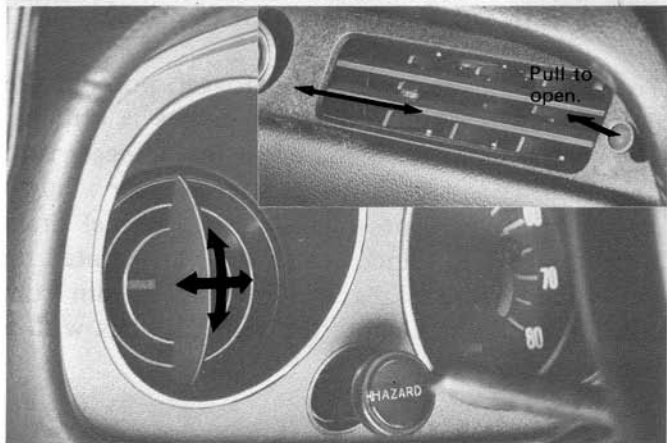
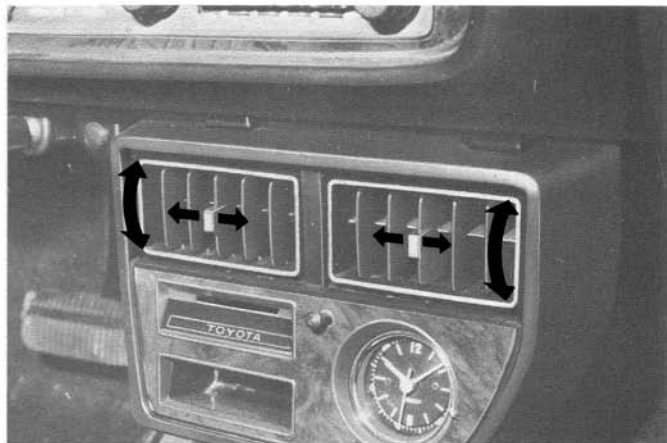

HEATER & BOOST VENTILATION (Option)

The heater & boost ventilation system controls consist of three control levers; one of these levers also functions as the switch for blower. The functions of the control levers and switch are as shown.

Control Levers

- 1 Temperature control lever
- 2 Air intake control lever
- 3 Air flow direction control lever & Blower (Fan) Switch (Operates only when ignition switch is in the ON position.)

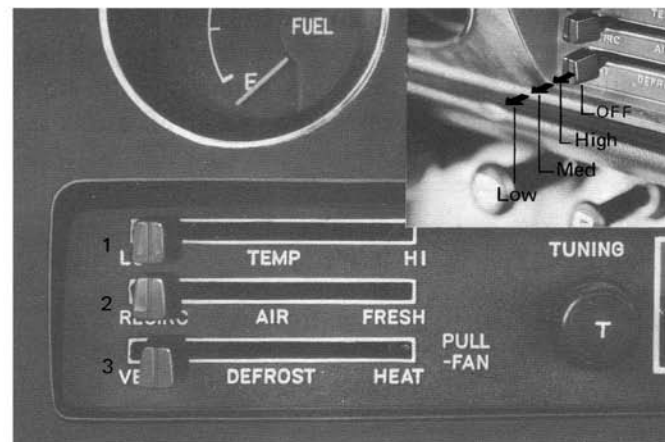

Heating

FRESH position: For normal driving conditions.

RECIRC (Recirculate) position: For heating the interior within a short time or when driving through dusty, sooty or smoky areas.

Windows will become fogged if the heater is used under this condition for any length of time during winter months and on rainy days.

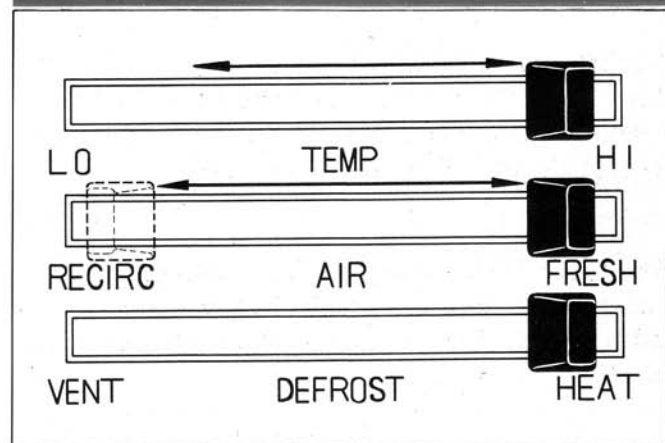

Warm Air to Feet and Cold Air to Head

Place the temperature control lever toward LO position and stop at the point where cold air flows through defroster nozzles and warm air from the heater.

Defogging and Defrosting (De-icing)

Warm air is directed to the windshield through the defroster nozzles, and the inside surface of the windshield is defogged.

Quick defrosting and de-icing operation is assured if the blower (fan) switch is operated at high speed. Move the air intake control lever to FRESH position when the windshield clears up.

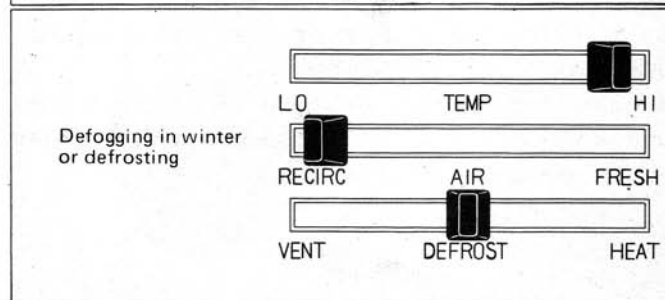
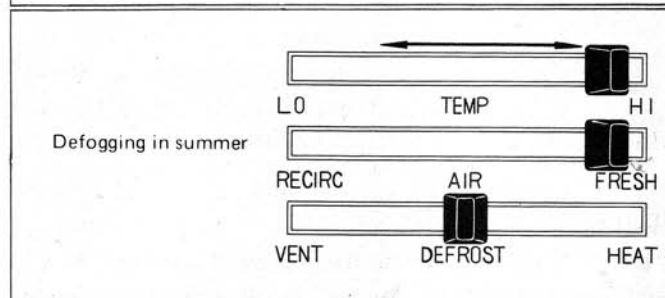
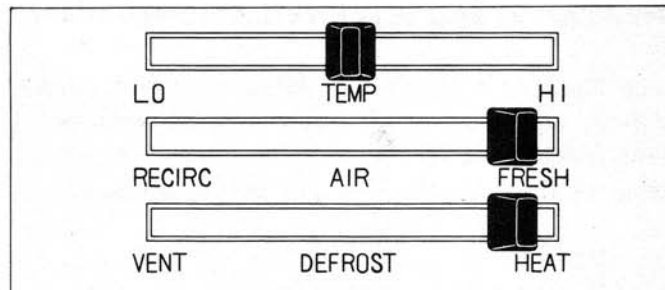

Boost Ventilation without Heating

Set the control levers as shown and operate the blower. The fresh air is forced into the interior through the center ventilation louver even when parking the car.

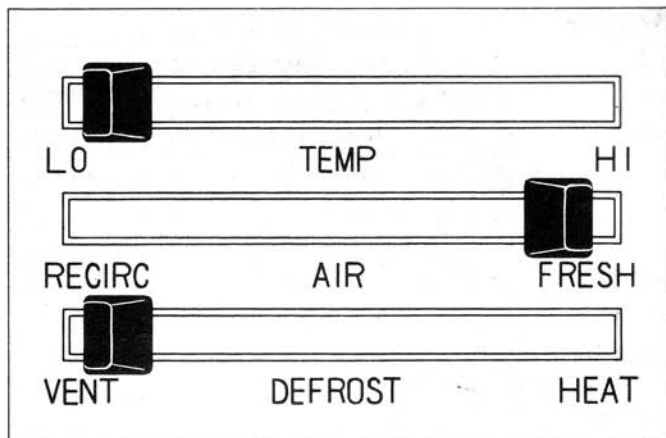

AIR CONDITIONER (Option)

The air conditioner system controls consist of four control levers; one of these levers also functions as the switch for the blower. The functions of the control levers and switch are as shown.

Control Levers

- A Heating control lever
- B Air intake control lever
- C Air flow direction control lever & Blower (Fan) Switch
- D Cooling control lever

Blower (Fan) Switch (Operates only when ignition switch is in the ON position.)

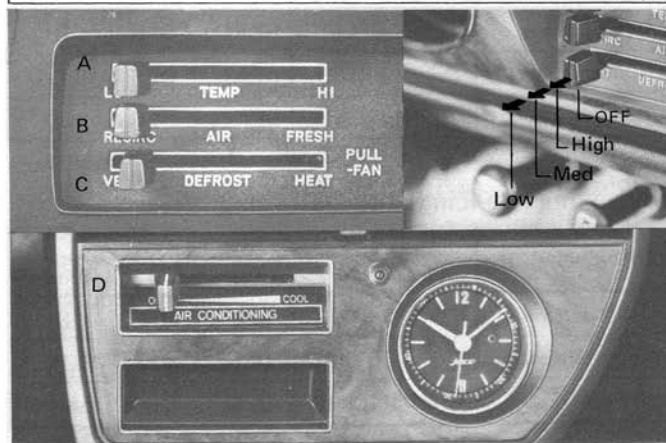

Cooling

Operation	Lever position				
	A	B	C	D	Blower
Quick cooling	LO	RECIRC	VENT	3~4	HI
Normal cooling	LO	RECIRC	VENT	2~3	MED-LO
Mild cooling	LO	RECIRC	VENT	1	LO
Boost ventilation	LO	FRESH	VENT	OFF	HI-MED-LO

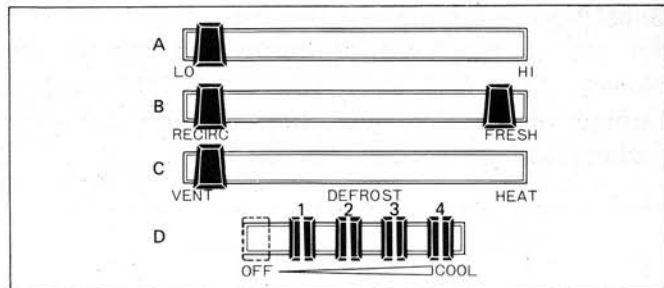

Heating

Operation	Lever position				
	A	B	C	D	Blower
Quick heating	3	RECIRC	HEAT	OFF	HI
Normal heating	2~3	FRESH	HEAT	OFF	MED-LO
Mild heating	1	FRESH	HEAT	OFF	LO

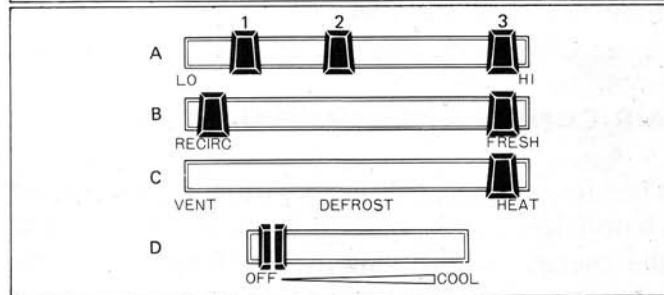

Defrosting (De-icing) and Defogging

Operation	Lever position				
	A	B	C	D	Blower
Quick defrosting	3	RECIRC	DEF	OFF	HI
Normal defrosting	2~3	RECIRC	DEF	OFF	HI-MED
Defogging	1~2	FRESH	DEF	OFF	HI-MED-LO

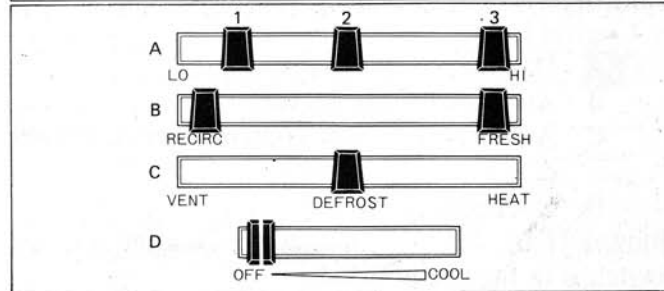

Dehumidified Heating

Season	Lever position				
	A	B	C	D	Blower
Winter	3	RECIRC	HEAT	1~2	HI-MED
Spring, Autumn	1~2	RECIRC	HEAT	1~2	MED-LO

Tips for Top Performance

Improper handling will result in unsatisfactory cooling performance.

1. Keep Out Hot Air

Keep all windows and ventilators closed when using the air conditioner to prevent outside air from inhibiting cooling effect.

2. Parking in Direct Sunlight

If the car has been parked in direct sunlight, open all the windows for 4 or 5 minutes while driving before operating the air conditioner to let heat out of the car interior. This increases cooling efficiency.

3. Driving on Rainy Days

To clear misted windows on rainy days, lower the temperature in the interior by operating the air conditioner.

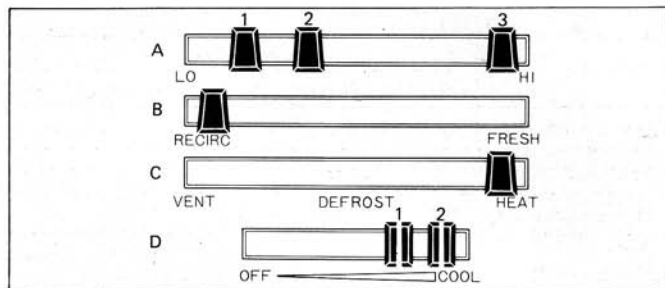

4. City Driving

When driving in heavy traffic, insufficient cooling may occur because of constant stop and go driving.

In this case, drive in a lower gear position to obtain sufficient cooling effect.

5. Uphill Driving

When driving on extended uphill grades, the engine is apt to overheat. To prevent this, turn the air conditioner on and off at 3 or 4 minute intervals instead of operating it continually. Coolness can be retained for 3 or 4 minutes after turning the air conditioner off.

6. During Off-season

Operate the air conditioning system for a few minutes once every week to lubricate the inside of compressor.

ENGINE HOOD

To open the engine hood, pull the hood lock release lever. The hood will spring open slightly. Lifting the hood completely will automatically lock it.

To close the hood, lift the hood slightly and pull the hood stay, then gently press it down to lock in place.

LUGGAGE COMPARTMENT

To unlock the luggage compartment, use the master key and turn it fully clockwise. To lock, just press down on the trunk lid until it locks in position.

Take care not to leave the key inside the luggage compartment when closing.

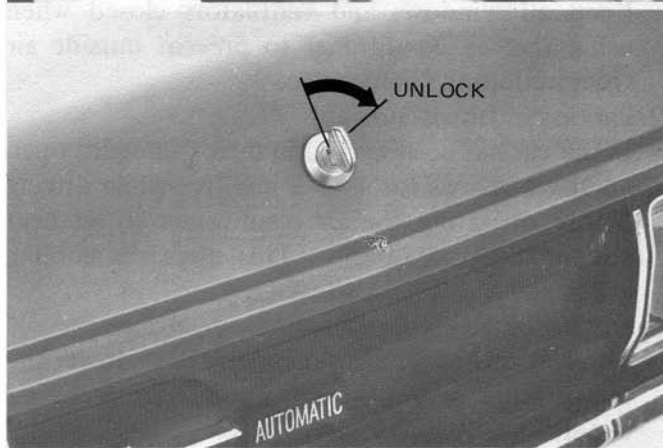
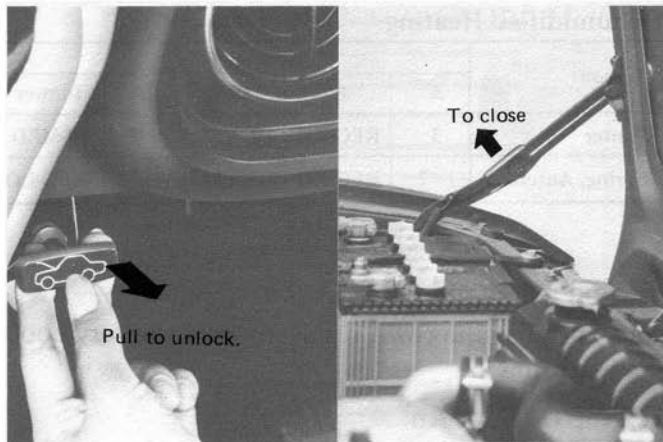

TOOLS, JACK AND SPARE TIRE

The tools shown below are standard equipped in your car.

Always store the tools, jack and spare tire in their specified locations as shown.

- | | |
|---------------------------------------|-------------------------|
| 1. Tool bag | 5. Wheel stopper |
| 2. Spark plug wrench | 6. Open end wrenches |
| 3. Pliers | 7. Wheel wrench |
| 4. Screwdriver (Phillips and regular) | 8. Jack and jack handle |

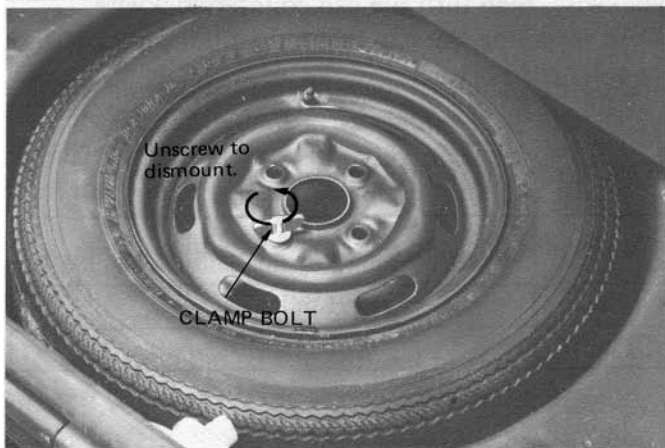
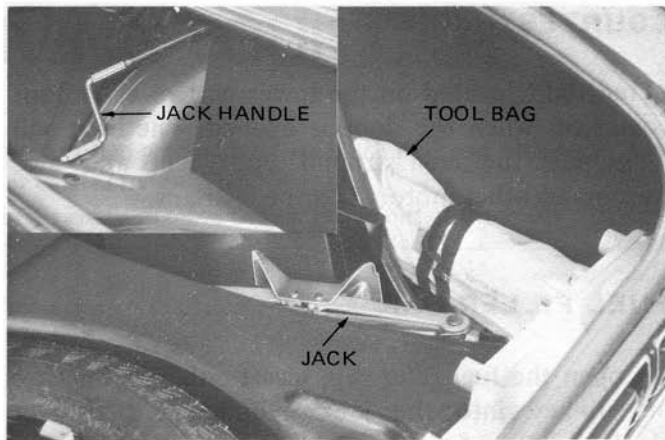
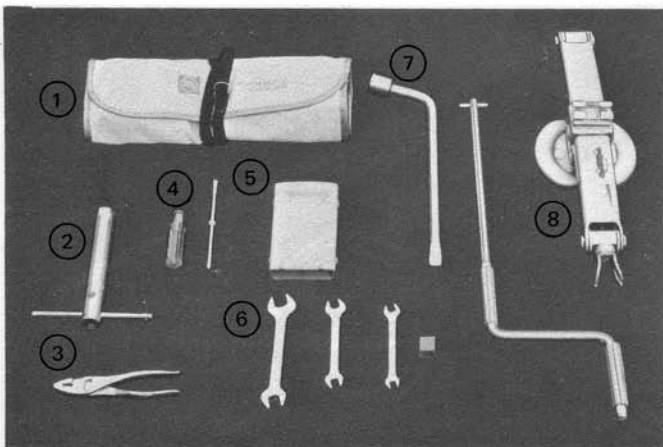

COURTESY LIGHTS

A red light located on the lower part of each door comes on when the door is opened. The light will illuminate the area around your feet and give warning to other motorists or pedestrians.

FUEL FILLER CAP

To open the fuel filler cap, insert either the master or sub-key into the lock cylinder and turn it clockwise, then turn the cap counterclockwise. When installing the cap, align the filler cap claw and the inlet cut portion.

FUEL RECOMMENDATION

Model	Octane Number (as determined by the Research Method)
LT	91 or higher
ST & GT	98 or higher

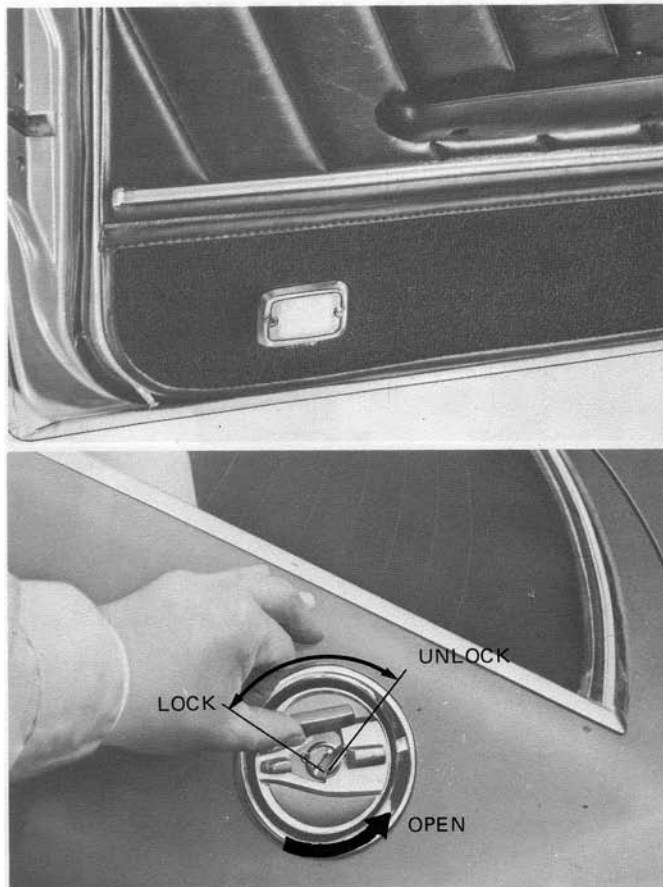

STARTING AND DRIVING YOUR CAR

WARNING: Avoid inhaling exhaust gases because they contain carbon monoxide which is colorless and odorless. Serious injury – even death – results when carbon monoxide is inhaled for an extended period.
Do not run the engine in a garage or enclosed areas longer than necessary to move the car in and out of the area.

How to Start the Engine

Before Starting

Just take a minute to check the following items.

- Engine coolant for proper level
- Engine lubricant for proper level
- Clutch and brake fluid for proper levels
- Tires for proper inflation (visually inspect.)

New Car Operation Tips

If you observe a few precautions for the first 1,000km (600 miles), your car life will be prolonged with added economy.

Drive your car moderately until the engine is properly warmed-up. The speed during this period should be limited to a maximum of 100km/h (65 mph) with moderate stopping and starting, but do not drive for extended periods at any one speed.

Avoid full throttle starts and sudden stops, especially during first 500km (300 miles).

Do not race the engine without load or do not drive at low speeds with the transmission in high gear.

1. Apply the parking brake fully.
Turn off headlights and accessories like the heater to stop unnecessary electrical draw from the battery.
Shift into neutral and hold the clutch depressed. Depressing the clutch helps the engine turn over easily—especially in cold weather—and ensures against accidentally starting the engine with the transmission in gear.
3. Toyoglide automatic transmission.
Place the selector lever in P (Park) or N (Neutral) position. A starter safety switch is provided, therefore, the engine can not be started in any position other than P or N position.
4. Start the engine according to the Starting Techniques.
Release the key when the engine starts, and depress the accelerator pedal slightly until the engine begins to run smoothly. Exercise care not to overspeed the engine when it starts. (Check the warning lights and gauges on the instrument panel for proper function.)

CAUTION To prevent damage to starter, do not hold ignition key in **START** position after engine starts.

If engine fails to start, return the ignition key to either ON or ACC, then repeat the starting procedure pausing a few seconds before the next starting to make sure that the starter fully engages the engine flywheel gear. Each cranking should be as short as possible to preserve battery charge. Do not crank the engine more than 15 seconds on each attempt.

5. Warm-up—It is beneficial for the engine to idle and warm up for a short period after starting. Drive at moderate speeds for several kilometers or miles, especially during cold weather.

STARTING TECHNIQUES

Cold Engine

1. Pump the accelerator pedal once.
2. ST & GT—Pull the choke button half way out.
3. Turn the ignition key and crank the engine without depressing the accelerator pedal until the engine is started.
4. ST & GT—When the engine is started, push in the choke button part way gradually to the position where the engine runs smoothly.

CAUTION: Never drive with the choke button pulled out after engine is warmed up.

LT—After running the engine at fast idle speed, reduce it by slightly depressing the pedal and releasing.

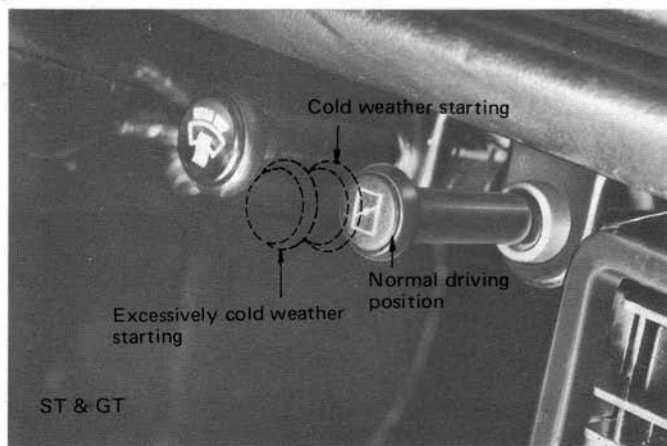

Excessively Cold Weather

1. Pump the accelerator pedal two or three times.
2. ST & GT—Pull the choke button all the way out.
3. Turn off all the lights and accessories.
4. While holding the clutch pedal to the floor, turn

the ignition key and crank the engine with foot off the accelerator pedal until the engine is started.

CAUTION: If the engine fails to start, do not unnecessarily pump the accelerator pedal as this procedure only enriches the mixture and makes starting more difficult.

5. ST & GT—When the engine is started, push in the choke button part way gradually to the position where the engine runs smoothly, and warm up for a few minutes. Push in the choke button completely.

LT—When the engine is started, warm it up for a few minutes. Then reduce idle speed by slightly depressing the accelerator pedal.

Warm Engine

1. Depress the accelerator pedal half way and hold it. Never pump the pedal. (When the engine is very hot, fully depress the pedal.)
2. Turn the key to START.
3. When the engine is started, release the accelerator pedal to reduce engine speed.

Flooded Engine

1. Fully depress the accelerator pedal and hold it to the floor for 15 to 20 seconds.
2. Turn the ignition key and crank the engine while holding the pedal to the floor until the engine is cleared of excess fuel and begins to run smoothly.

Never pump the accelerator pedal.

1. If the engine fails to start by trying the above procedure, remove all spark plugs, dry if wet, and keep the spark plug bores open until excess fuel in the combustion chambers has cleared. Reinstall spark plugs and repeat the above procedure.

How to Drive with a Manual Transmission

The manual transmission has four or five forward speeds and one reverse and follows the shift pattern shown in the illustration.

Fully depress the clutch pedal before shifting into any gear. After shifting, release the clutch pedal slowly. Shift into reverse gear only after the car has fully stopped.

Before descending a steep or long grade, reduce speed and downshift the transmission to a lower gear to use the engine as a brake. Downshifting to a lower gear helps maintain a safe speed and prevent brakes from overheating and losing effectiveness.

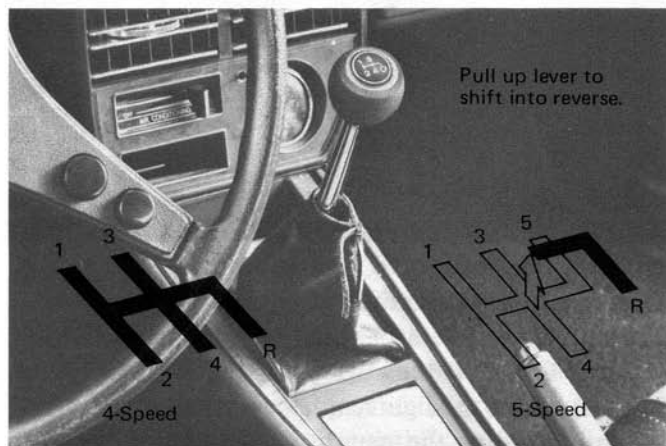

Do not rest your foot on the clutch pedal while driving to avoid premature clutch wear and improper clutch operation.

Maximum Allowable Speed (at 6,500 rpm)

Transmission	4-speed		5-speed
	km/h (mph)		
Diff. Gear Ratio	3.900	4.111 (OPT)	4.111
1st Gear	50 (30)	45 (28)	45 (28)
2nd Gear	90 (55)	85 (53)	85 (53)
3rd Gear	130 (80)	120 (75)	120 (75)
4th Gear	—	—	170 (105)

These speed limits are the maximum allowable speeds up to which the car can be driven or at which the car can be downshifted without overrunning the engine in each gear. When you need to reduce speed due to slow-moving traffic, turning corners, or driving up steep hills, downshift to a lower gear before the engine starts to labor.

Excessive knocking, resulting from low-speed lugging of the engine, may result in engine damage and may be harmful to the power train, too.

How to Drive with an Automatic Transmission

Toyoglide Automatic Transmission has three forward speeds and one reverse speed.

The shift position is indicated on the console box. If the light switch is on at night time, shift position indicator light will go on.

Take your foot off the accelerator pedal when shifting selector lever to any drive position with the engine on.

When selector lever is placed in D position, the car will start with 1st speed and automatically shift up



Selector-lever can be moved by depressing the lock release button.



Selector-lever can be moved without preceding operation.



(P) PARK—Place the selector in this position when parking the car. Be sure to shift into P position after the car has completely stopped. The engine can be started when the selector is in this position.



(R) REVERSE—This position is for reversing the car. Shift into or from R position after the car has come to a complete stop.



(N) NEUTRAL—Gears are free in mesh and it is possible to start the engine when the selector is in this position.



(D) DRIVE—This is the position for normal driving.



(2) SECOND—This position is to use slight engine braking effect.



(L) LOW—This position is to use maximum engine braking effect.



to 2nd and 3rd speeds as vehicle speed is increased. If rapid acceleration is required while driving with the selector placed in D position, kick-down the accelerator pedal with the selector remaining in the same position. The transmission will automatically downshift to either second gear or low gear in accordance with the vehicle speed.

Toyoglide can be used like a manual transmission by shifting manually from L, 2 and then to D position as speeds increase.

The allowable speed in the respective range is as shown below.

Exercise care not to allow the engine to overspeed.

Maximum Allowable Speed (at 6,500 rpm)

Diff. Gear Ratio	km/h (mph)	
	4.111	4.300 (OPT)
Low Range	50 (30)	45 (28)
2nd Range	100 (65)	95 (60)

When reducing speed, utilize engine braking effect by downshifting. It is possible to downshift from D to L position directly. In this case, first downshift is made automatically to second gear and then to low gear as the vehicle speed decreases.

WARNING: Never downshift if the vehicle speed is above the allowable speeds.

Down-shifting at maximum allowable speeds generates excessive deceleration stress and the down-shift speeds should be used less than approximately 90km/h (55 mph).

WARNING: If engine stalls while car is in motion, place the selector in N position before restarting. Never shift into P position when the car is moving.

Do not depress the accelerator pedal to rev up the engine with the parking brake applied and the selector lever placed in any drive position. This causes fluid overheating and possible damage. Never attempt abrupt starts by increasing the engine speed while the service brake is applied and then releasing brake pedal. Otherwise, transmission parts may be subjected to damage or premature wear.

Driving Hints

USING YOUR BRAKES

Driving through deep water puddle may affect braking effectiveness due to moisture inside the brake drums. To dry them quickly, depress the brake pedal lightly a few times while running at a slow forward speed until the brakes return to normal.

When descending a steep or long grade, reduce speed and shift transmission into a lower gear position. Apply brakes sparingly so that they do not overheat.

When applying brakes at high speeds, depress the brake pedal a little at a time to gradually reduce speed. Sudden application of brakes at high speeds may lock all four wheels and cause loss of control in forward movement, which could result in a serious traffic accident.

Overheated brake linings reduce brake effectiveness, and extra pedal pressure is required to obtain the

same braking effect as that when normal. Excessive heating of the brakes will cause the brake fluid to boil and form bubbles. The force depressing the brake pedal merely compresses these bubbles and does not act on the brake linings with resultant loss in brake effectiveness.

DRIVING ON WET ROADS

When it begins to rain, road surfaces become slippery. When water collects on the road surface, the traction becomes poor, and there is the additional danger of hydroplaning at high speeds.

Hydroplaning occurs when a water film forms between the tire and road surface so that the tire skids over the water instead of gripping the road. It reduces or eliminates vehicle control and stopping ability. Observe the following precautions to prevent possibility of traction loss:

- 1. Reduce speed in heavy rains or when roads are slippery.*
- 2. Slow down when driving through puddles.*
- 3. Keep tire inflation pressure as specified.*

DRIVING ON SNOW OR ICE

In winter conditions, road surfaces are frequently slippery and are most hazardous in freezing weather. Snow tires, chains or studded tires are recommended. If you must drive without these, drive as slowly as possible at a constant speed. Control your speed by means of engine braking effect or downshift to a lower gear. Harsh braking under such conditions may cause the car to skid. Keep enough distance between your car and other cars so that you do not have to apply brakes suddenly.

CAR BOGGED DOWN IN SOFT GROUND

If the car bogs down in soft ground, determine the direction of escape, i.e., forward or backward, and then shift the transmission into 1st or reverse gear. Engage and disengage the clutch rhythmically while keeping the engine pulling gently to rock the car free.

If your car is equipped with an automatic transmission, shift the selector lever alternately into D and R positions and escape in the manner identical to the above.

Avoid over-revving the engine and excessive spinning of the rear wheels. If you are still stuck after a minute or two of rocking, have the car pulled out to avoid overheating and possible damage to the transmission.

HOLDING CAR ON AN UPGRADE

To stop on an upgrade for a short period of time, hold your car by applying the parking brake. Never attempt to hold the car in place by accelerating the engine with the transmission in gear or with the selector lever in any drive position. On cars equipped with manual transmission, this practice requires slipping the clutch, thus generating heat in the clutch disc and hastening wear or damage to the clutch.

On cars equipped with Toyoglide, this may result in overheating of the transmission fluid.

PARKING YOUR CAR

Turn the ignition key to the LOCK position, remove

the key, close all the windows, and lock the doors when leaving your car unattended.

When parking on an upgrade, stop your car parallel to the curb, and cut the front wheels sharply and allow the car to roll back until the back of the front wheel comes in touch with the curb, turn off ignition switch, apply parking brake and put your car in 1st gear or P position.

On a downgrade, cut the front wheel and allow the car to move forward until the front of tire comes to rest against the curb. Shift transmission into reverse or P position. It may be advisable to block front or rear wheels on a steep grade.

When parking a car equipped with an automatic transmission on a slope, the car may still be locked even after shifting the lever into other position from P position.

When backing the car on an uphill, shift to D and move the car forward a little as a preliminary step, then shift into R for backing.

When descending a hill, shift into R and back the car a little as a preliminary step, then shift into D to move the car forward.

WARNING: Never leave your car unattended with engine idling and children inside the car. Children may play with driving controls out of curiosity, and this could lead to an accident.

EMERGENCY STOP

If you must stop your car on a busy highway, pull it over to the edge of the road as far as possible; do not park on the driving lane.

Apply the parking brake and turn on the hazard warning lights, day or night, to warn other drivers of the hazard.

1. The hazard warning lights operate regardless of the position of the ignition switch, and even without the key.
2. The hazard warning lights can be used for about 5 hours without the engine running, provided that the battery is fully charged.

If you must leave your car to call for assistance, lock all the doors.

EMERGENCY STARTING

Push Starting

Turn on the ignition switch, depress the clutch pedal, and shift to 2nd or 3rd gear. Hold the accelerator pedal about halfway down. When car speed reaches about 15km/h (10 mph), slowly release the clutch pedal to start engine.

WARNING: Do not attempt to start the engine by having your car towed. The sudden forward surge when engine starts may cause a collision with the car ahead.

It is not possible to push-start the engine, if your car is equipped with an automatic transmission.

Jump Starting

Jump starting can be dangerous if done incorrectly. Always follow these instructions:

Care should be exercised in the following points when performing jump start.

- a. Use a 12-volt booster battery.
 - b. Connect jumper cables so that they do not contact each other.
 - c. Turn lights, radio and accessories OFF while cranking.
1. Obtain a fully charged battery (one in another vehicle may be used) and two jumper cables.

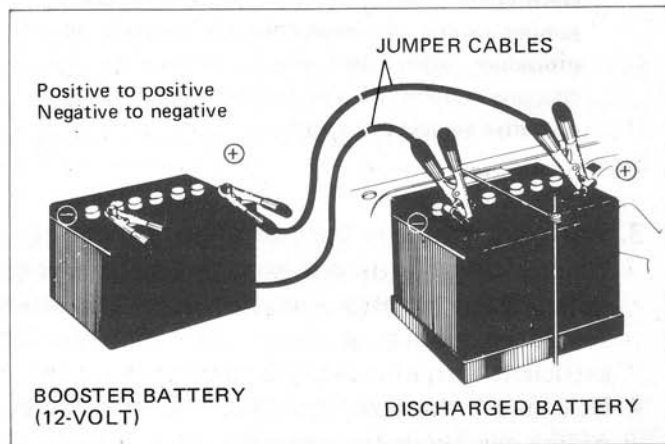

2. Connect one end of a jumper cable to the positive terminal (identified by either + or P on the battery case or post) of the booster battery and the other end of the same cable to the positive (+) terminal of the discharged battery. Connect one end of the other jumper cable to the negative terminal (- or N) of the booster battery and its other end to the negative terminal of the discharged battery. Connections must be clean and secure.

WARNING: Never make wrong connections of jumper cables. If connections are made in any procedure other than above, damage to the charging system of the booster vehicle or in-operative vehicle will result.

3. Start your engine in the normal manner.
When your car battery is being boosted by jumper cables from another car, the other car engine should be running at about 2,000 rpm to ensure sufficient current is being supplied.
4. Disconnect the jumper cables following the procedure exactly in reverse order.

ENGINE OVERHEATING

The following symptoms indicate engine overheating:

- a. The coolant temperature gauge reading 120°C (250°F) or higher.
- b. Excessive engine ping.
- c. Loss of engine power.
- d. Steam or boiling water venting the radiator.

WARNING: To remove the radiator cap:

Do not remove radiator cap if the engine and radiator are still hot, because steam and scalding water under pressure will blow out, which may cause bodily injury.

When the engine has cooled, place a thick rag like a towel over the radiator cap, slowly rotate the cap counterclockwise to the detent. This procedure allows any residual pressure to relieve. When the hissing sound has stopped, press down on the cap while turning counterclockwise, and remove it.

If overheating is detected, take the following steps:

1. Stop the vehicle and open the engine hood to provide good ventilation.
2. Check fan belt to see whether broken or loose and look for coolant leaks. If found defective, stop the engine immediately.
3. If checks are OK, run the engine at a speed (about 1,500 rpm) slightly higher than idling speed to bring down the temperature. Watch to see whether the indicated temperature drops within 5 minutes. If not, stop the engine.
4. After running the engine, stop it and carefully remove the radiator cap.
5. Check the coolant level and replenish with fresh water up to about 20mm(0.8") below the bottom of the filler neck.

Possible causes of engine overheating are incorrect ignition timing, a loose fan belt, insufficient amount of engine oil or coolant, or clogged or blocked radiator. Determine the cause of trouble, and correct it as soon as possible.

OIL PRESSURE DROPS (ST & GT models) or OIL PRESSURE WARNING LIGHT COMES ON (LT model)

If the oil pressure drops while the engine is running, immediately stop the engine.

CAUTION: Do not run the engine when the oil pressure is low, otherwise the engine may be damaged.

Check the oil level and, at the same time, check for leakage. If necessary, replenish oil, restart the engine, and check to see that oil pressure rises to normal or warning light goes out.

If pressure does not rise or the light does not go out even with sufficient oil in the crankcase, or if lubricant is leaking, obtain assistance.

AMMETER INDICATES CONSTANT DISCHARGE (ST & GT models) CHARGE WARNING LIGHT COMES ON (LT model)

This indicates that the battery is not being charged. Immediately stop your car and check for a loose or

broken fan belt. If loose, adjust the belt tension as instructed on page 57.

If the belt is broken, replace it. If the fan belt is not responsible for the discharge reading, have your car inspected and corrected.

WARNING: Driving under this condition will eventually discharge the battery. If the fan belt is loose or broken, overheating of engine will result. Do not drive for a long time if the charging system is inoperative.

TOWING

When being towed, secure the rope to one of the tie-down hooks located at the front of each side member. (An optional front towing hook is available for long-distance towing.)

When towing someone else, tie the rope on the rear towing hook. Tow smoothly—do not let the line slacken and then pull tight violently. Tow only for a short distance.

If your car must be towed, make sure the parking

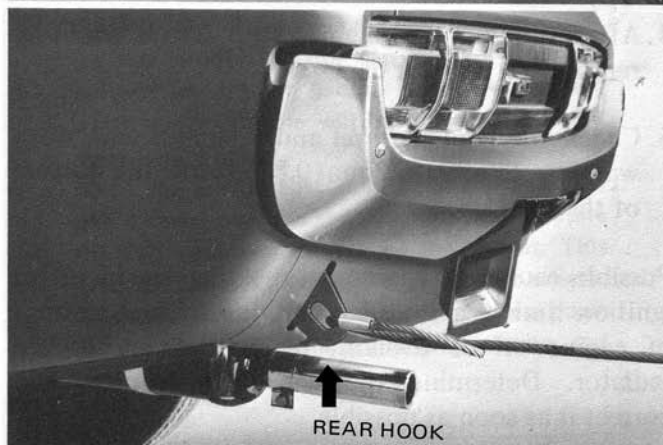
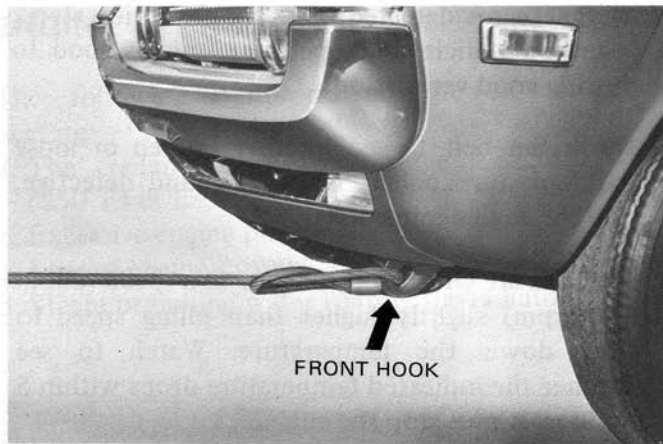

brake is released and the transmission is in neutral. Turn the ignition key to the ON position, then return it to ACC position to prevent accidental locking of the steering column. It is important that the transmission, rear axle, and drive shaft are in good operating condition.

However, if your car is equipped with an automatic transmission, have it towed with the propeller shaft disconnected from the differential even though

there is no problem with the transmission. This is to prevent damage to the transmission due to insufficient lubrication.

To move a vehicle with an inoperative rear axle, raise the rear wheels off the ground and keep the front wheels in a straight ahead position.

If the transmission is locked, raise the rear wheels or disconnect the propeller shaft, whichever is more convenient.



MAINTAINING YOUR CAR

Scheduled Maintenance

To maintain your car in top driving condition, it is vitally important to have it inspected and serviced periodically. Maintenance service is based on season and month (mileage). The seasonal service will vary in accordance with the climate and place of driving. The periodic service is based on a 3-month or 5,000km (3,000 mile) interval. Your Toyota Dealer has all the information pertaining to maintenance and service of your car and can provide all service for your car. Or, if you wish, you can perform some of the service yourself, as explained in the following pages. In either case, however, be

sure to closely follow the maintenance schedule below to make sure that all servicing is performed at the proper time. If your car is driven under the following conditions, the servicing interval should be shortened.

- Driving in freezing weather, during rainy season, on excessively rough or dusty roads
- Frequent short trips
- Continuous high speed driving
- Trailer hauling
- Extensive idling

CELICA MAINTENANCE SCHEDULE

R means "Replace" or "Change".

SERVICE INTERVAL (Odometer reading or months, whichever occurs first)		Months	—	3	6	9	12	15	18	21	24	27	30	33	36	39	42	45	48	51
		ODOMETER READING																		
MAINTENANCE ITEMS		x 1,000 km	1	5	10	15	20	25	30	35	40	45	50	55	60	65	70	75	80	85
		x 1,000 miles	0.6	3	6	9	12	15	18	21	24	27	30	33	36	39	42	45	48	51
LUBRICATION	Change engine oil		R	R	R	R	R	R	R	R	R	R	R	R	R	R	R	R	R	R
	Check & replenish steering gear box oil						O				O				O					O
	Check & replenish or change transmission & differential gear oil				O		O		R*1		O		O		R*1		O		O	
	Check & replenish or change automatic transmission fluid		O	O	O	O	O	O	R*1	O	O	O	O	O	R*1	O	O	O	O	O
	Pack front wheel bearings & lubricate ball joints											O								O
	Lubricate front shock absorber upper support bearings											O								O
	Change brake fluid							R				R			R					R

*1 every 30,000km (18,000 miles) or every 24 months, whichever occurs first.

SERVICE INTERVAL (Odometer reading or months, whichever occurs first)		Months																			
		—	3	6	9	12	15	18	21	24	27	30	33	36	39	42	45	48	51		
		ODOMETER READING																			
MAINTENANCE ITEMS		x 1,000 km	1	5	10	15	20	25	30	35	40	45	50	55	60	65	70	75	80	85	
		x 1,000 miles	0.6	3	6	9	12	15	18	21	24	27	30	33	36	39	42	45	48	51	
ENGINE	Replace engine oil filter		R		R		R		R		R		R		R		R		R		
	Change engine coolant (wo/long life coolant)						R				R				R				R		
	Change engine coolant (w/long life coolant)										R								R		
	Check battery electrolyte level & specific gravity		○	○	○	○	○	○	○	○	○	○	○	○	○	○	○	○	○	○	○
	Check fan belt deflection		○		○		○		○		○		○		○		○		○		○
	Check distributor cap, rotor, points & gap		○		○		○		○		○		○		○		○		○		○
	Check & clean or replace spark plugs		○		○		R		○		R		○		R		○		R		○
	Clean or replace air cleaner element			○	○	○	○	○	R	○	○	○	○	○	R	○	○	○	○	○	○
	Replace fuel filter										R										R
	Tighten nuts & bolts on engine		○																		
	Check valve clearances		○		○		○		○		○		○		○		○		○		○
	Check ignition timing & advance operation		○		○		○		○		○		○		○		○		○		○
	Check engine idle speed & carburetor condition		○		○		○		○		○		○		○		○		○		○
	Check resistive cords resistance										○										○
Check fuel pipes, hoses & connections for leaks & damage		○				○		○		○		○		○		○		○		○	
Check cooling system hoses, pipes & connections for leaks & damage		○		○		○		○		○		○		○		○		○		○	
Check or replace PCV valve						○				R				○						R	
CHASSIS & BODY	Check brake pad & disc			○	○	○	○	○	○	○	○	○	○	○	○	○	○	○	○	○	○
	Check & clean brake lining & drum						○			○				○				○			○
	Check brake booster operation						○			○				○				○			○
	Check brake pedal free play & parking brake travel		○	○	○	○	○	○	○	○	○	○	○	○	○	○	○	○	○	○	○
	Check clutch pedal free play		○		○		○		○		○		○		○		○		○		○
	Check steering free play, linkage, front & rear suspension & ball joints		○		○		○		○		○		○		○		○		○		○
	Rotate tires			○		○		○		○		○		○		○		○		○	
	Check front end alignment (side slip)		○				○				○				○				○		
	Check leakage of oil, fuel & fluid & damage of brake pipes & hoses		○		○		○		○		○		○		○		○		○		○
	Tighten nuts & bolts on chassis & body		○				○				○				○				○		

Non-scheduled Maintenance

The following maintenance operations are not required at regular intervals. But we recommend that these checks should be performed when required or at the time as explained hereunder.

Of course, these checks can be done by yourself, and some of these checks are explained in the following pages.

Before Starting

- Check engine oil level
- Check engine coolant level
- Check clutch & brake fluid level
- Check tire inflation (visually)

While Driving

- Check rear view mirrors
- Check windshield wiper & washer
- Check headlight aiming

At Gas Station

- Check engine hood lock
- Check accelerator linkage
- Check all lights and switches

At Least Once a Month

- Check tire inflation pressure, wear, cuts & cracks
- Check door lock
- Check steering lock
- Check seats
- Check seat belts (option)
- Washing & waxing

Season In or Out

- Change air intake control lever position on air cleaner (option)

Maintenance You Can Do

This section provides inspection and maintenance procedures that most anyone can easily perform. If you “do it yourself”, some of these checks should

be done periodically according to the Maintenance Schedule on page 48.

ENGINE

ENGINE LUBRICATING OIL & FILTER

Proper engine oil level should always be maintained. The best time to check it is before starting the engine or as the last step in a fuel stop.

If the level is low, add oil (API service SD-SE classification engine oil). To check the oil level, stop the engine, make sure the car is level, pull out the dipstick and wipe it clean with a rag, reinsert it all the way, and then pull it out again to see the reading.

1. The level is satisfactory if it is between the F and L lines marked on the dipstick. It will be necessary, however, to add oil soon if the level is close to the L mark, so check frequently.

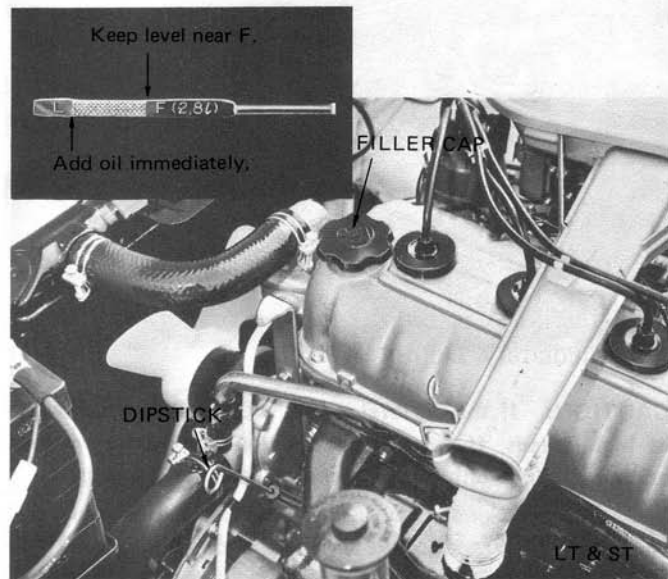

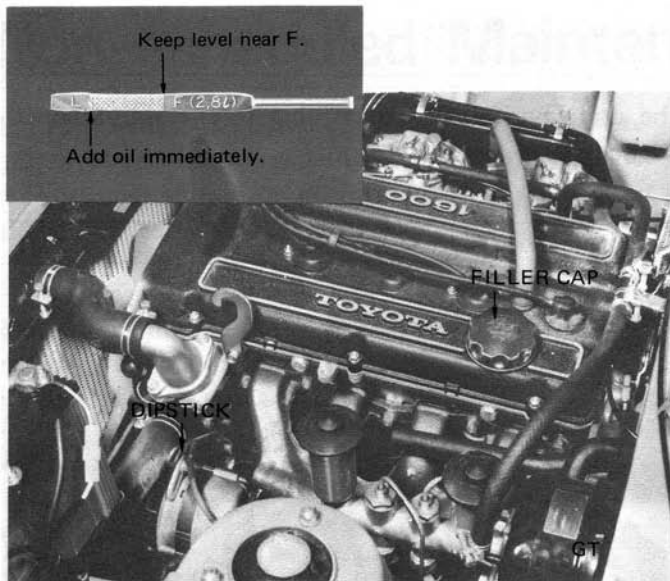

2. If the level is on the L line or below, add oil immediately. Do not overfill.

CAUTION: If the oil level is low, **DO NOT** run the engine at high speeds. If for any reason you must drive without adding oil, drive only for a short distance at low speeds.

If you change the oil yourself, use the following procedure.

1. Park your car on level ground and warm up the oil by running the engine for 5 to 10 minutes.
2. Stop the engine and remove the filler cap. Place an oil receptacle (about 5 liters or 1¼ gal.) below the drain plug.
3. Remove the drain plug using a 24 mm wrench and drain the oil.

WARNING: Be careful not to be scalded with hot oil when draining.



4. When the oil is completely drained, wipe off the oil around the drain hole and install the drain plug with a gasket fitted. (Replace the drain plug gasket once every four oil changes).
Securely tighten the plug but do not overtighten.
5. Replace the oil filler, if required.
6. Fill the crankcase with new engine oil of the proper grade (API service SD-SE classification engine oil) and viscosity through the filler hole. Use the amount shown below, depending on whether the oil filter has been replaced.

Crankcase only

LT & ST	2.8 liters	3.0 US qt.	2.5 Imp qt.
GT	2.9 liters	3.1 US qt.	2.6 Imp qt.

Total

LT & ST	3.7 liters	3.9 US qt.	3.3 Imp qt.
GT	3.8 liters	4.0 US qt.	3.3 Imp qt.

7. Start the engine and run it at low speed for a few minutes, then stop the engine.
Remove the dipstick and check for proper level.

To remove the oil filter, turn it counterclockwise using a suitable band wrench. Wipe the mounting surface of the filter bracket clean. Screw on the new oil filter but tighten only hand-tight; do not use a wrench.

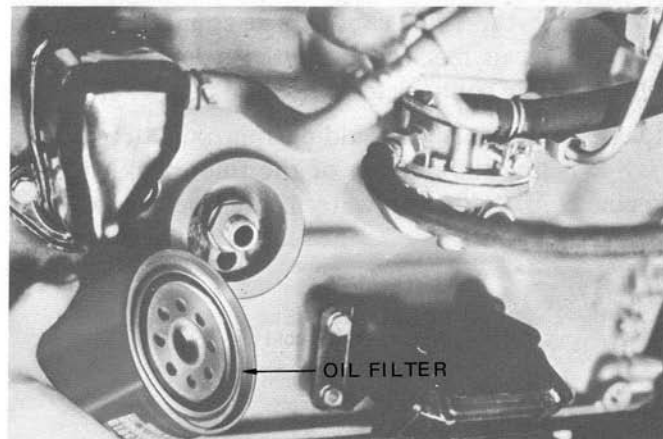

ENGINE COOLANT

WARNING: Personal injury may result if the cap is removed improperly when engine is hot. See page 44 for the correct procedure.

CAUTION: Hard water and alkaline water should never be used in the cooling system under any circumstances.

Check the coolant level at each engine oil level check.

To remove the filler cap, turn it counterclockwise. When the cap reaches the detent, depress the cap while turning counterclockwise and remove it.

The level of coolant should be approximately 20mm (0.8") below the bottom of the filler neck with the engine cold. Add clean water if the level is low.

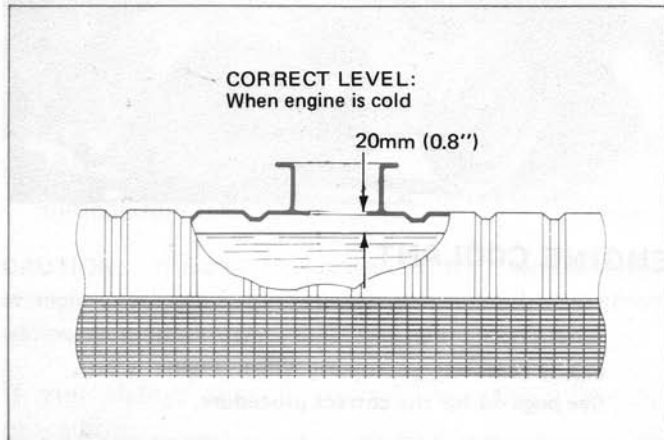

The filler cap should be securely tightened or the coolant will overflow, resulting in engine overheating and possible damage to the engine.

If the atmospheric temperature drops to 0°C (32°F), the water may freeze with possible damage to the engine block and radiator. To prevent the water from freezing, completely drain it and thoroughly flush the cooling system with clean water. Add the proper quantity of anti-freeze or long life coolant and fill with clean water until the cooling system is full. Start the engine when the water level approaches the full level and add water while running the engine at idle speed.

The proportion of anti-freeze or long life coolant and water varies according to their specification and to the temperature fall in your area. Follow the instruction of the manufacturer.

Coolant Capacities:

Models	Liters	US qt.	Imp. qt.
LT & ST	6.5	6.9	5.7
GT	7.4	7.8	6.5

Anti-freeze has a tendency to cause the engine to overheat in the hot season and is detrimental to metal surfaces. Therefore, if an anti-freeze is used, completely drain the coolant when the winter months are over, thoroughly flush the cooling system and refill with clean water to provide adequate corrosion protection.

The long life coolant will prevent freezing in winter and act as a corrosion preventive. It may be used for two years without changing.

If the level of coolant drops within a short period of time after replenishment, either leakage in the cooling system or defective radiator cap is probably responsible. Check the following items and have fault corrected if any trouble is detected.

- 1. Leakage from the joint of the radiator hose or heater hose, fitting of the radiator drain cock and water pump.*
- 2. Damaged or aged radiator cap valve or weakened valve spring.*

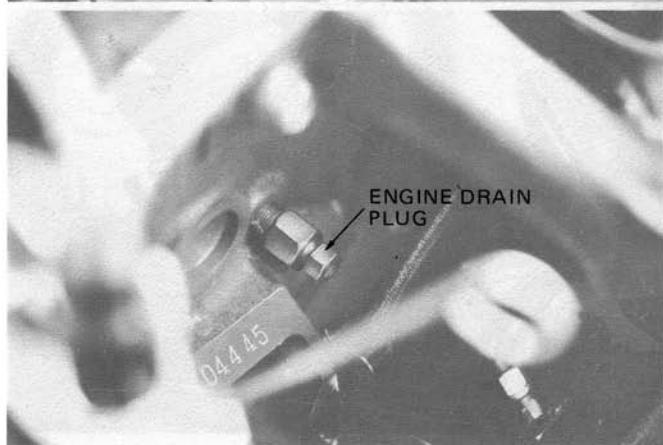
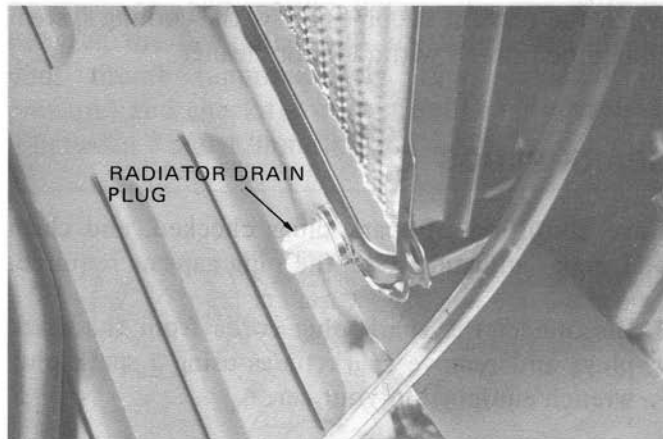

When the coolant becomes dirty, the cooling system should be flushed with radiator cleaner.

SPARK PLUGS

Have condition of spark plugs checked, and clean and make adjustment of the plug gaps as required.

1. Disconnect the spark plug cords from the spark plugs and remove spark plugs using a spark plug wrench equipped in your car.

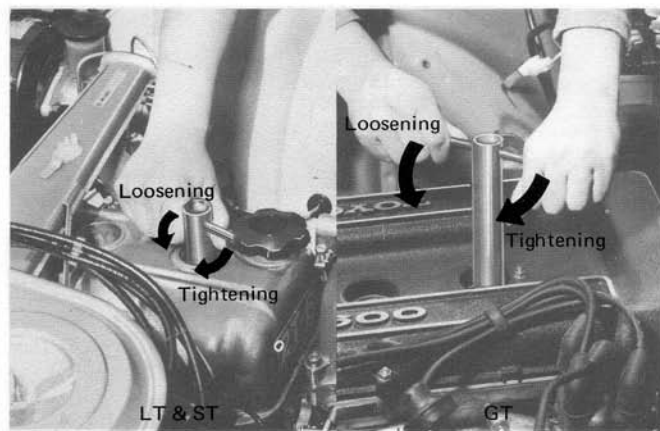

2. Thoroughly clean the spark plugs using a sand blast cleaner.
3. Adjust the spark plug gaps by bending the ground electrode to obtain the specified gap of 0.8mm (0.031") with the spark plug gap gauge.

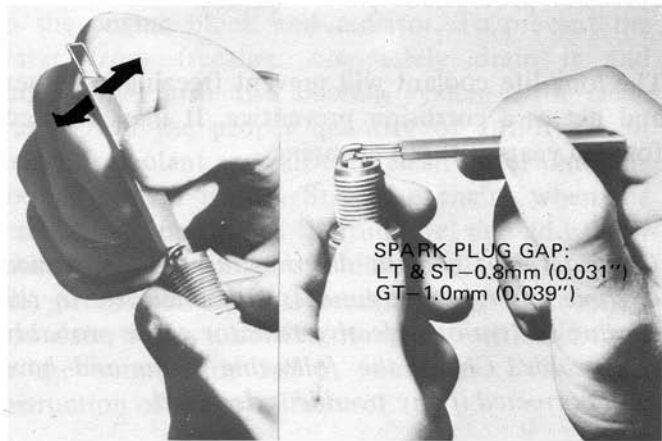

4. Reinstall the plugs onto the engine and tighten them with the spark plug wrench. Do not overtighten.
5. Securely connect the spark plug cords.

Improper or faulty spark plugs have a considerable effect on engine performance. Be sure to use standard spark plugs.

Standard Spark Plug

Model	Nippondenso	NGK
LT & ST	W16EP	BP5ES-L
GT	W16EX	BP5EZ

Different driving patterns and conditions have different effects on spark plug performance. When checking spark plugs, note the type of deposits and the amount of electrode wear around the spark gaps. If the electrodes are burnt, then replace with "cold" type spark plugs. If the electrode end is blackened with carbon, then replace with "hot" type spark plugs.

WARNING: Do not mix spark plug types and/or heat ranges at any one time.

FAN BELT

Check the belt for cracks, wear and stretch, and replace it with a new one if it is found damaged.

To check the belt tension, depress the belt halfway between the fan pulley and alternator pulley with your thumb (approximately 10 kg or 22 lb of pressure) and check the deflection. The proper slack is between 8 and 12mm (0.3 and 0.5").

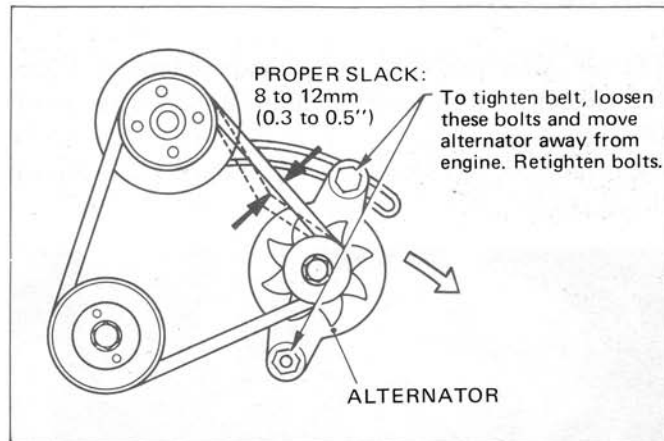

If slack is excessive, loosen the alternator bracket bolt and the bolt of the adjusting bar (see figure) and move the alternator away from the engine. The service life of the belt is drastically shortened if it is loose.

Securely tighten the alternator bracket bolt and the

adjusting bar bolt after adjusting the belt. If the belt is replaced, readjust the tension after approximately 1,000km (600 miles) when it has become stretched.

AIR CLEANER

The air cleaner of your car is a paper element. Clean the element with compressed air; do not wash or oil it.

Clean and replace earlier after extensive driving on dusty roads.

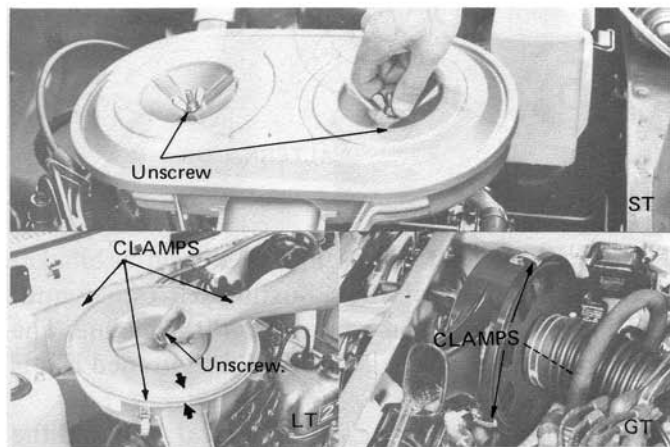

Align the arrow on the case cover with that on the air inlet when installing the element for LT model. Always keep the air cleaner element installed to prevent dust from entering the engine. Make sure that gaskets of the case and cover are properly fitted when installing the element.

As an optional equipment in some areas, the engine (only for LT and ST models) is provided with an air cleaner which is equipped with a valve capable of changing air suction ports.

Labels reading SUMMER and WINTER are adhered on the case of this air cleaner. Set the valve in SUMMER position when the ambient temperature is high (spring, summer and fall). Fresh air is directly introduced into the air cleaner. When the ambient temperature is low (winter), set this valve to WINTER position. Fresh air heated near the exhaust manifold will be introduced into the air cleaner. This system will assist in maintaining good engine performance.

To move the valve for LT model, first loosen the wing-nut, move it to either SUMMER or WINTER position, then tighten it securely. To move the valve for ST model, pull the lever away from the air inlet, then turn it to either SUMMER or WINTER position.

CHASSIS

BRAKES & CLUTCH

Fluid Level

Check the brake and clutch fluid levels at each engine oil level check. The level is correct if it reaches the ridge in the upper part of each reservoir. If the level is lower, add fluid (SAE J1703) as specified on page 77. Do not overfill.

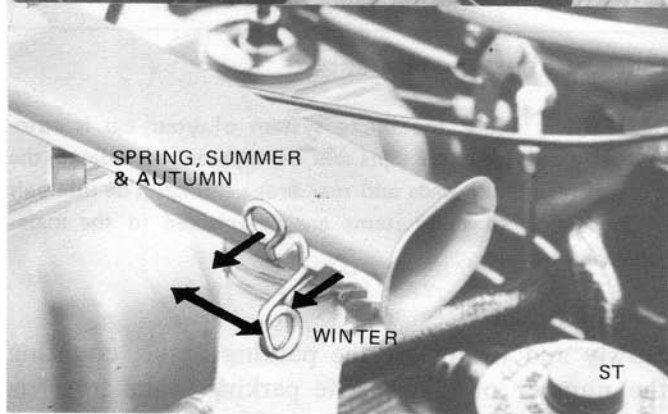
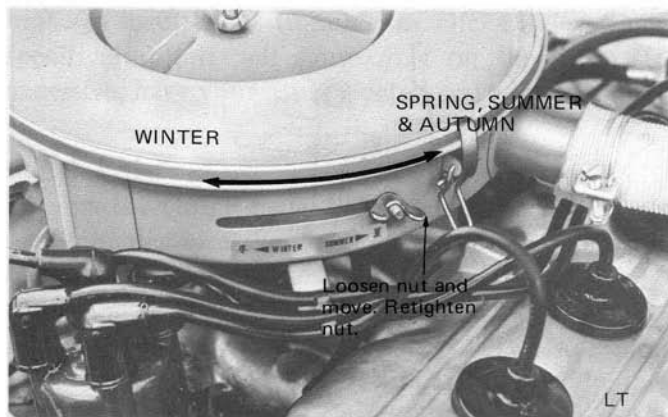
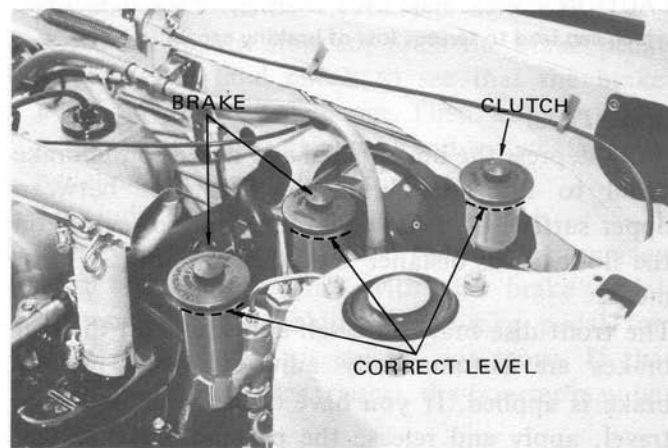

CAUTION: Do not forget to reset the lever to **SUMMER** position when the cold season is over.

WARNING: Exercise care in handling brake fluid as it may cause damage to painted surfaces and is harmful to the eyes.

Since the disc brakes are used on the front wheels, the fluid level of the brake master cylinder drops as the brake pads become worn. If the fluid level is lower than specified, add fluid.

The brake fluid should be changed periodically according to the maintenance schedule.

CAUTION: Brake fluid has a tendency to absorb moisture which can lead to serious loss of braking capability.

Brake Pedal

Fully depress the brake pedal and measure the brake pedal to floorboard clearance (distance between upper surface of pedal pad and surface of carpet on the floor). This distance should be 55mm (2.2") or more.

The front disc brakes are self-adjusting and the rear brakes are automatically adjusted when parking brake is applied. If you have excessive brake pedal travel, apply and release the parking brake several

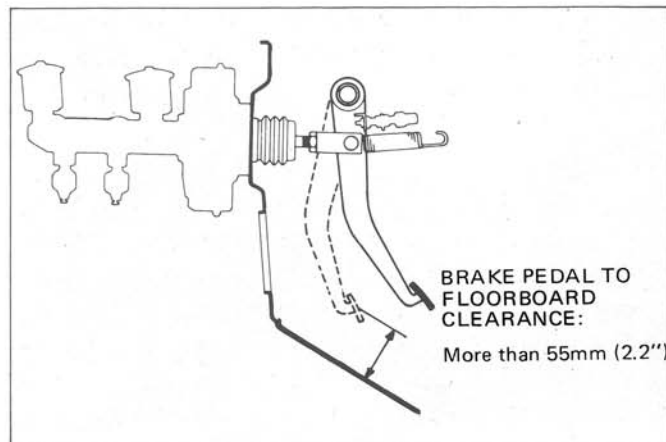

times to adjust the clearance.

CAUTION: Since the brake system of your car is automatically adjusting, no signs will be apparent to indicate the wear of disc brake pads and rear brake linings. The intervals of inspection of these items are determined in the maintenance schedule.

Parking Brake

Slowly and firmly set the parking brake, counting the number of clicks. The parking brake travel is satisfactory if it gives between 6 to 12 clicks (3 to 6 notches). If the brake shoe clearance in the rear

brake is insufficient (number of clicks is less than specification), it will cause drag on the drum. If excessive, have your car inspected and adjusted.

Clutch Pedal

Depress the clutch pedal lightly, and check the free play (the distance the clutch pedal travels from the completely released position to the point where clutch pressure is felt).

The free play is satisfactory if it is between 25mm and 45mm (1.0 and 1.8"). Excessive play in the clutch will result in poor clutch disengagement.

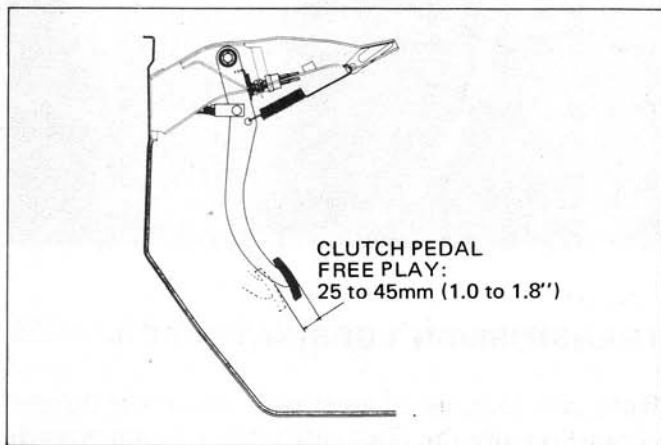

BRAKE BOOSTER

Check the brake booster for operation following the sequence given below.

If any malfunction is detected, have your car inspected and repaired.

1. Run the engine for a minute or so, stop the engine, and press the brake pedal a few times. The pedal travel should be greater the first time. The travel should decrease in subsequent applications. If pedal height remains unchanged (pedal travel does not decrease), the booster may be defective.
2. With the engine stopped, press the brake pedal several times and check to see that the brake pedal travel does not change. Then, keeping brake pedal depressed, start engine and see whether the pedal moves down a little further. This indicates that the booster is normal.
3. Press the brake pedal while running the engine. Then stop the engine with the brake pedal depressed. After holding the brake pedal for about 30 seconds, it should not move. If the pedal height increases (raises), the booster may be defective.

STEERING GEAR

Lubricating Oil

A single viscosity (SAE 90) of gear lubricant can be used in the steering gear housing throughout the year.

Check lubricant level and check for leakage, and add proper lubricant (API service GL-4 classification gear oil) up to the level of filler hole, if necessary.

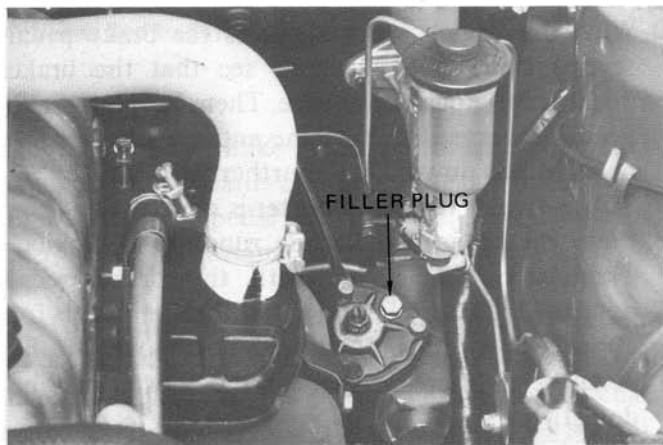

Steering Wheel

Turn the steering wheel gently in both directions when the front wheels are positioned straight ahead. The steering wheel should have no play when it is properly adjusted. If the play is more than 20mm (0.8"), have it adjusted.



TRANSMISSION LUBRICATING OIL

When checking the oil level, stop the vehicle on level ground, remove the filler plug using a 12mm wrench,

and feel inside the hole. If the level is lower than the edge of the hole, add lubricating oil of Toyota specification (API service GL-4 classification gear oil). A viscosity of SAE 90 is satisfactory throughout the year. Reinstall the filler plug.

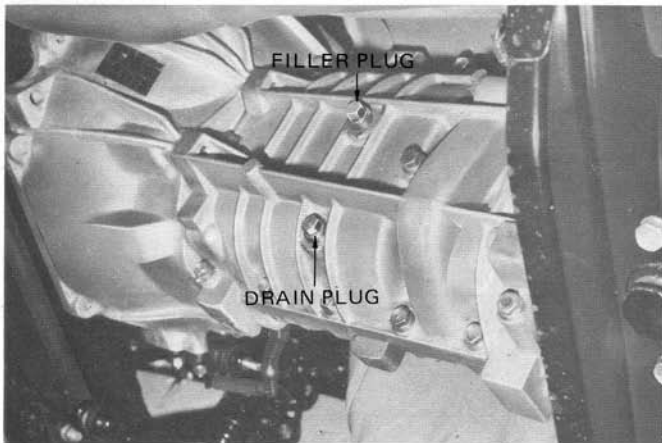

Lubricant Capacities:

Liters	US qt.	Imp. qt.
1.5	1.6	1.4

AUTOMATIC TRANSMISSION FLUID

To check fluid level, park the car on level ground and apply parking brake fully.

Then start the engine, and with the engine at idle speed, shift the selector into all the positions from P position through L position, then shift into N position.

Check the level by means of level dipstick after the above operation. To check the level, pull out the dipstick and wipe it clean with a rag, reinsert it all the way, and then pull it out again to see the reading.

The level is satisfactory if it is within COLD range marked on the dipstick when fluid temperature is low before running, and the level is satisfactory if it is within HOT range marked on the dipstick when fluid temperature is high after running.

If the level is low, add automatic transmission fluid (ATF Type F) as specified on page 77 through the dipstick hole.

Fluid Capacity:

Liters	US qt.	Imp. qt.
7.0	7.4	6.2

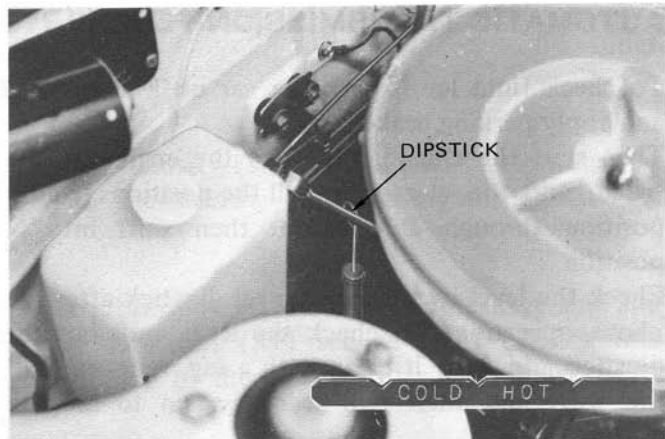

DIFFERENTIAL LUBRICATING OIL

Check the level of the differential oil with the vehicle parked on level ground, remove the filler plug using a 24mm wrench, and feel inside the hole. The level must be up to the filler plug hole. If the level is low, add lubricating oil of Toyota specification (API service GL-5 classification gear oil). Check for leakage from the rear axle housing at the same time.

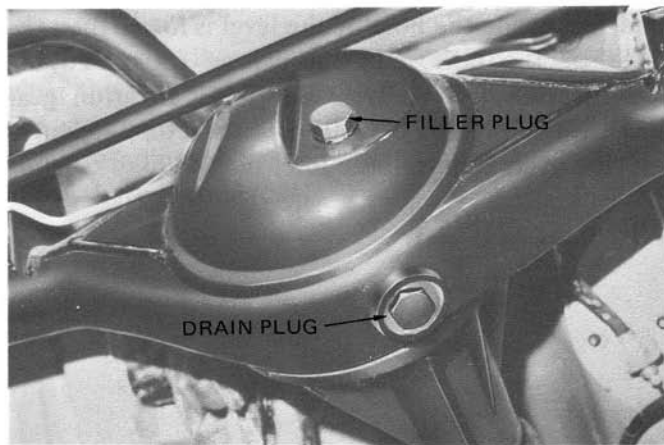

Lubricant Capacity:

	Liters	US qt.	Imp. qt.
LT & ST	1.0	1.06	0.88
GT	1.1	1.17	0.97

BALL JOINT GREASE

Lubricate the front suspension lower ball joints. To lubricate the ball joint, remove the screw plug using a 10 mm wrench and screw on the grease fitting.

Grease with molybdenum-disulphide lithium base grease. While greasing, force out old grease from the grease outlet of the boot. After greasing, replace the grease nipple with the original screw.

If dust boots are found broken, have them replaced and greased.

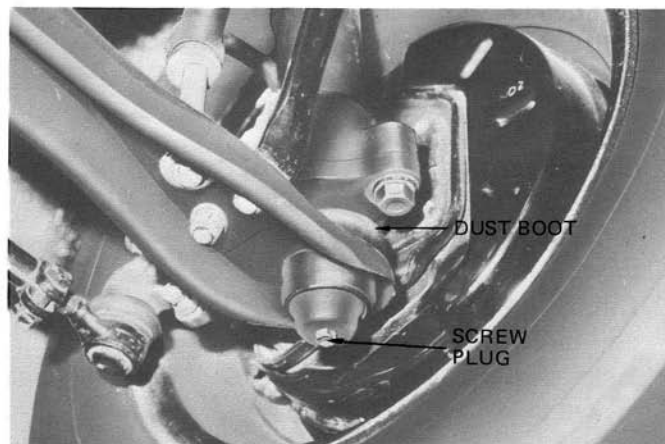

TIRES

The factory-installed tires on your car were selected to provide the best combination of reliability,

traction, stability at high speeds, load carrying ability and riding comfort for all normal operations.

For good vehicle performance and personal safety, always be sure that passenger and luggage weights are evenly distributed.

A monthly check should be made for uneven tire tread wear, tire casing cuts or cracks, improper tire inflation pressure (including spare), and loose wheel nuts.

When your tire tread is worn as shown, the tire

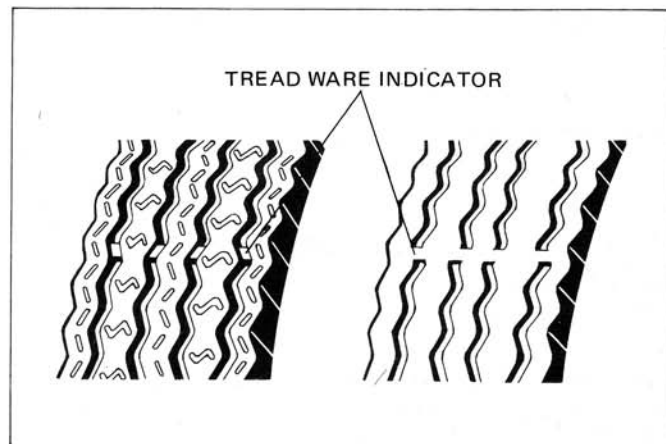

should be replaced.

Be sure to use the factory recommended sizes. Do not use both conventional and radial tires at the same time.

Tire Inflation Pressure

Always check the tire inflation pressure when the tires are cold. It is best if the car has not been driven for three hours, but if it is necessary to drive just before checking, the distance should be within 1.5km (1 mile).

Recommended Cold Tire Inflation Pressure

TIRE SIZE	CAR SPEED		
	Below 100km/h (60 mph)	100 to 150 km/h (60 to 90 mph)	Above 150km/h (90 mph)
6.45S-13 4PR 165SR 13 165HR 13	1.5kg/cm ² (22 psi) for front & rear	1.8kg/cm ² (26 psi) for front & rear	2.4kg/cm ² (34 psi) for front & rear

CAUTION: High speed driving increases the tire temperature and air pressure. Routine tire pressure inspection should not be performed when the tires are hot.

If the tire pressure is high, fuel consumption is improved, but riding comfort is sacrificed. If the tire pressure is low, riding comfort improves, but fuel consumption increases and steering is sluggish. High speed driving with low tire pressure causes tire overheating which can lead to blowouts and serious accidents. Tire pressures higher or lower than recommended will shorten tire life, decrease driving stability, and adversely affect braking performance.

Tire Replacement

1. Take out the spare, jack and handle, wheel nut wrench, and wheel stopper.
2. Firmly set the parking brake before jacking up, and block the wheel diagonally opposite from the jack position, so that the car will not roll when jacked up.
3. Remove the wheel cap using the flat end of wrench and loosen the wheel nuts slightly.
4. Position the jack as noted here, and raise the car until tire clears the ground.

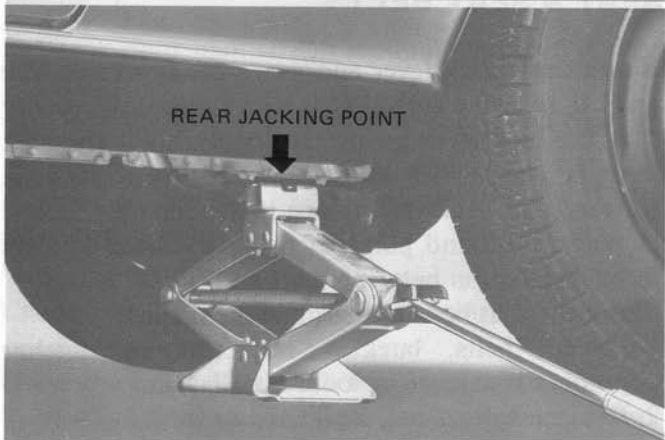
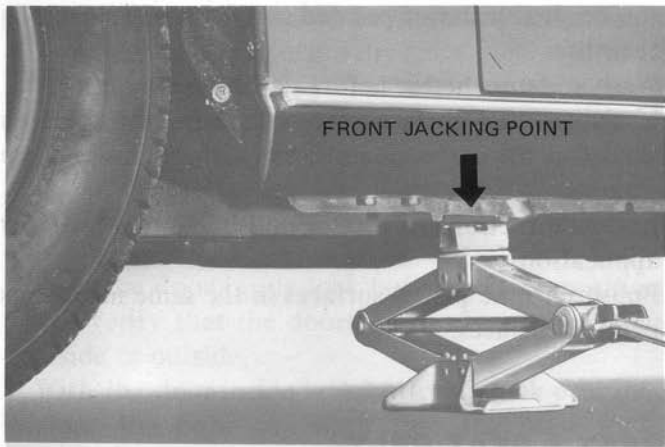

5. Remove the wheel nuts and wheel, install spare, and tighten wheel nuts.
6. Lower the car and retighten the wheel nuts securely.
7. Install the wheel cap.

WARNING: Park the vehicle on level ground. Never get beneath the car when it is supported only by a jack. Always use safety stands to securely support car if it is necessary to get underneath.

BODY

WASHING & WAXING

It is important to take care of the painted and chrome-plated surfaces of your car.

Washing

Use cold or lukewarm water for washing your car. Do not use hot water for washing and do not wash while the car body is hot.

Remove mud and road grime with a sponge or soft rag, using enough water to avoid scratching.

Salt, chemicals, snow, or mud on the body should be washed off with water, and use a light detergent as required. Make certain, however, to use a neutral detergent, and thoroughly rinse it off.

Dry the water droplets by using a chamois or towel, wringing out often. If water droplets are allowed to dry on the surface, they will streak.

Waxing and Polishing

Polishing and waxing is recommended to maintain

the original luster of painted surfaces and to prolong their life.

Wash and dry the car before polishing or waxing.

If the painted surfaces are hot, move the car to a shaded place and wait until the surface cools before waxing.

Follow directions of wax or polish manufacturer for application.

Polish chrome plated surfaces in the same manner as painted surfaces.

SEAT & SEAT BELT

Release seat lock lever and move the front seat fore and aft to make sure that it slides smoothly. Verify that the lock lever spring effectively holds the lock lever in place. With the seat locked, try to move it forward and backward to see if it is securely locked in place. Push and pull seat backs to check for any loose installation between seats and floor.

Check the seat belt in the following manner.

1. Inspect belts, buckles, retractors and anchor points for damage or loose installation.
2. Replace belts if cut, weakened or frayed.

3. Keep sharp objects and bottles away from belts.
4. Keep seat belts clean and dry.
5. If necessary to clean the belts, use mild soap solution and lukewarm water. Never bleach or dye belts.

DOORS

1. Push the door inside lock button to lock position and verify that the doors cannot be opened from inside or outside.
2. With the door inside lock button in lock position, close the door to check that the door locks securely.
3. Check door lock striker retaining screws for loose fitting.
4. Lock and unlock each door with key and check if the operation is smooth.

HOOD LOCK

Check the hood lock release lever for smooth operation.

Open the hood and check that the hood stay locks in place to keep the hood securely in open position.

ACCELERATOR LINKAGE

With the car standing still, slowly depress and release the accelerator pedal. Make sure that the movement of the pedal is smooth. Check for any damage, missing parts, interference and binding of the linkage.

ELECTRICAL

BATTERY

When fully charged, specific gravity of battery electrolyte is 1.260 (when the electrolyte temperature is 20°C or 68°F). Recharging is required if the specific gravity drops to 1.200.

The level of electrolyte is satisfactory if it is within a range between the upper and lower level marked on the battery case.

If your car has a black battery case, the vent cap should be removed when checking the electrolyte level as noted in the illustrations.

Add distilled water if the level is low.

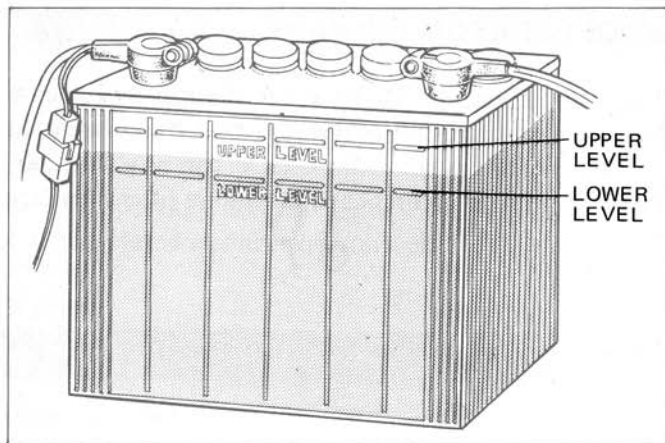

If the level of battery electrolyte is too high, it may squirt out during charge and may corrode the battery bracket and car body. Self-discharge may also result.

Check the battery case for cracks, clamps for looseness, and both terminals for corrosion and looseness. You may wash both terminals and the top surface of the case with lukewarm water. Coat grease on terminals to prevent corrosion.

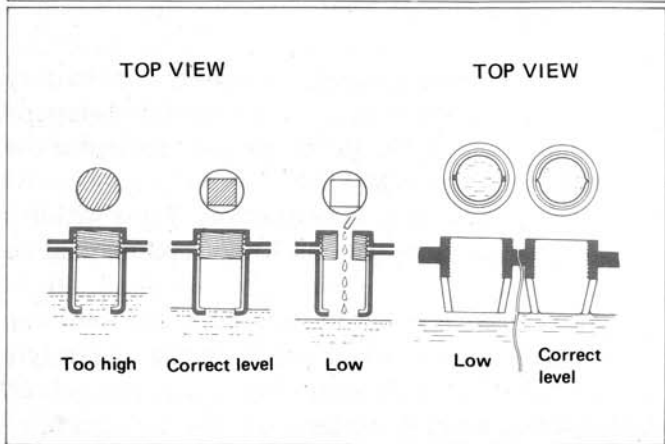

WARNING: Hydrogen gas is generated during charging. Never use an open flame nearby because this gas is highly explosive. Care should be exercised in handling electrolyte, as it is diluted sulfuric acid. It will cause skin irritation and ruin clothing and the surface of the car body. Particular care should be exercised not to get battery electrolyte into your eyes.

FUSIBLE LINK

The electric circuits are provided with a fusible link connected with the positive terminal of the battery.

Current always passes through the fusible link as it flows to all the electric devices except to the starter. A fusible link is a wire that melts before the entire wiring harness is damaged in the event of an electrical overload in the circuit.

WARNING: Always use a genuine Toyota fusible link. Never install a wire or electrical jumper for replacement as it may cause a fire hazard to the car.

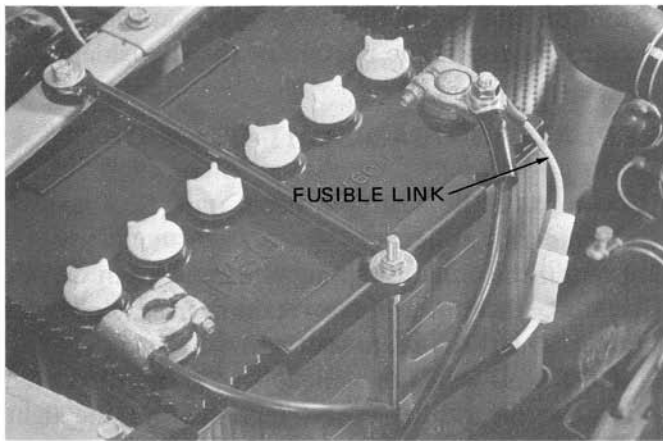

FUSE

The fuse block is located under the instrument panel. If any fuse is blown, turn off the ignition switch and the switch in the circuit in question, and install a new fuse of proper amperage. Then turn on the switches, and see if the electrical device operates. If the fuse immediately blows again, have your car inspected and serviced. Do not use fuses of higher amperage rating than those recommended.

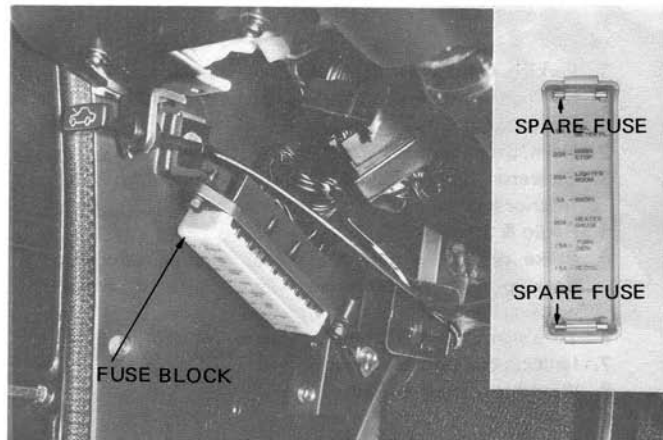

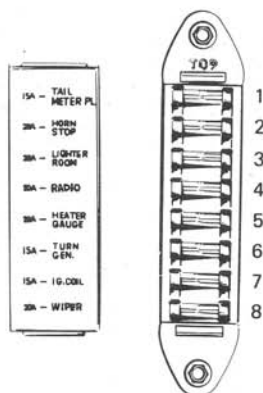

1. Parking lights, Tail lights, License plate lights, Glove box light, Instrument panel lights, Switch knob illumination lights
2. Horn, Stop lights & Hazard warning lights
3. Cigarette lighter, Clock, Door courtesy lights & Interior light
4. Radio & Stereo
5. Brake system warning light, Rear window defogger, Back-up lights, Heater blower, Gauges & Parking brake warning light
6. Turn signal lights & Voltage regulator IG terminal
7. Ignition coil positive terminal
8. Windshield wiper & washer

LIGHTS, SWITCHES & WINDSHIELD WIPERS

1. Inspect all switches for proper operation, lights for burned-out bulbs, and loose fitting or blown fuses.
2. Operate the windshield wipers while actuating the windshield washer and check that switchover from low speed to high speed and vice-versa is smooth. Verify that wiper blades uniformly wipe sufficient areas and that the washer fluid is sprayed properly.
3. Turn off the wiper switch while the wipers are in motion and assure that both wipers automatically come to stop at the bottom of the windshield.

REPLACING HEADLIGHT BEAM UNIT

1. To replace the headlight beam unit, first remove the radiator grille.
2. Loosen the three retaining screws (A), but do not remove them. Turn the retaining ring clockwise and pull out the beam unit with the ring.
3. If the semi-sealed type headlight is installed, first remove the rubber cover, then remove the light

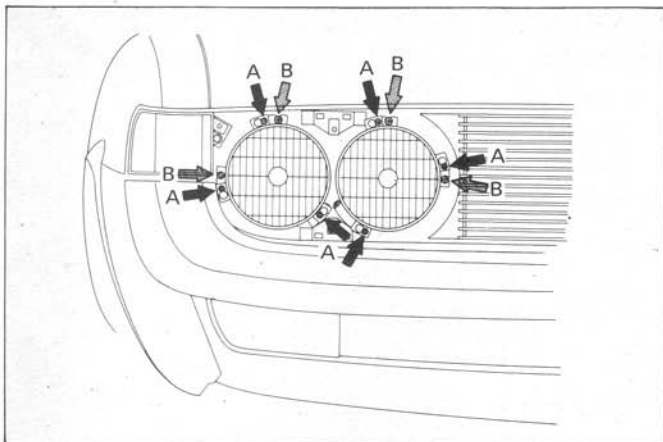

bulb by turning the ring nut counterclockwise as shown.

4. When installing the bulb, align the protrusion of the light bulb socket and the groove of the headlight lens, and make sure that the gasket of the ring nut is properly fitted.
5. After replacing, always check the headlight aim and adjust if necessary by turning screws (B). Since the job is best done with special equipment, we recommend that the adjustment be made by your Toyota Dealer.

6. Do not interchange the inner and outer headlight beams.

Sealed Beam Wattage

	Outer	Inner
Sealed beam type	37.5/50 watts	37.5 watts
Semi-sealed beam type	40 watts	45 watts

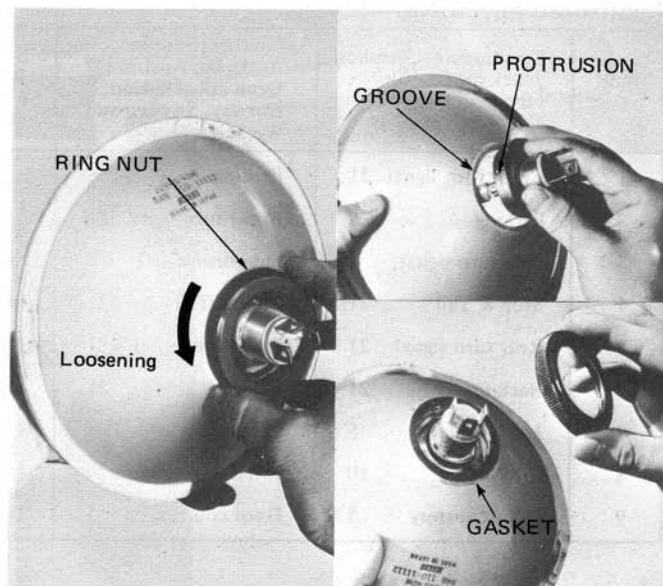

REPLACING LIGHT BULBS

If you need to replace the light bulbs, follow the procedures shown in the illustrations.

Press the bulb in and turn it counterclockwise to remove from the socket. The bulbs for the interior light and courtesy lights can be removed by pulling them out from the holders.

Light Bulb Specification

wattage

Bulb No.	Standard Specification (excl. models for the countries listed on the right)	Specification for Australia, Austria, Denmark, England, Norway, Sweden and West Germany	Specification for Belgium, Finland, France, Holland and Switzerland
1	Front turn signal 21	Parking 5	—
2	Parking 5	Front turn signal 21	Front turn signal & Parking 21/5
3	Side turn signal 8	Side turn signal 6	Side turn signal 6
4	Stop & Tail 21/5	Stop & Tail 21/5	Stop & Tail 21/5
5	Rear turn signal 21	Rear turn signal 21	Rear turn signal 21
6	Back-up 21	Back-up 21	Back-up 21
7	License plate 5	License plate 5	License plate 5
8	Interior 10	Interior 10	Interior 10
9	Door courtesy 5	Door courtesy 5	Door courtesy 5

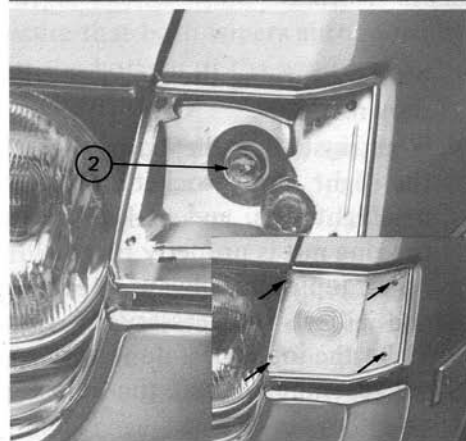

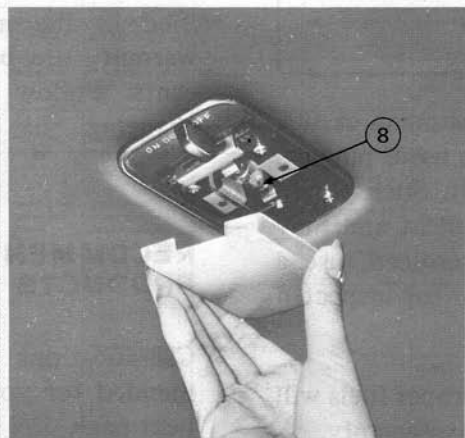
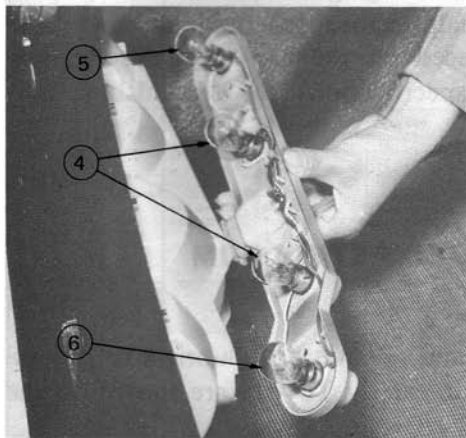
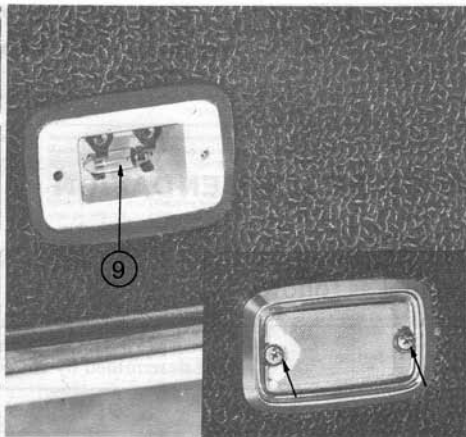
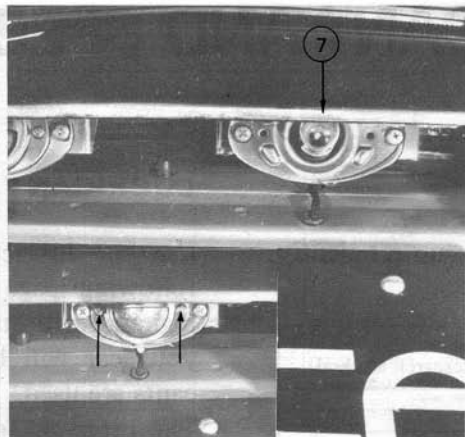
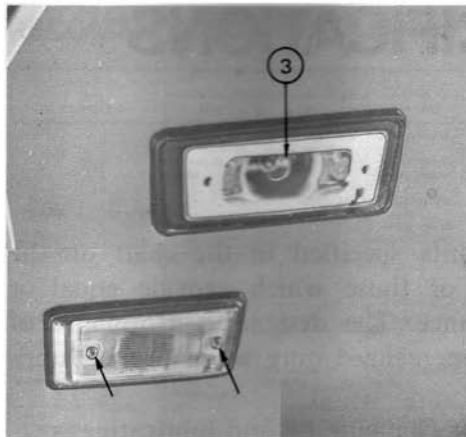

FUEL, LUBRICANT AND SPECIFICATIONS

FUEL RECOMMENDATION

The engine of your car is designed to run efficiently on fuel as follows.

Engine	Octane Number (as determined by the Research Method)
2T for LT	91 or higher
2T-B for ST 2T-G for GT	98 or higher

If the ignition timing is out of adjustment or if a fuel too low in anti-knock quality is used, pinging, spark knock or after-run may result. Such conditions may cause the engine to overheat and may damage it. If such symptoms are noticed, use a higher octane gasoline and have your car inspected for improper ignition timing.

Engine damage caused by use of improper fuels will not be covered under Toyota's new car warranty.

LUBRICANT

Use the lubricants specified in the chart on the following page or those which provide equal or higher performance. The designed performance of your car will be realized only when proper lubricants are used.

The intervals for changing oil and lubricating specified in the maintenance schedule and new car warranty are based on the use of qualified lubricants. Follow specifications for replenishing and changing.

RECOMMENDED PETROLEUM PRODUCTS

Classifications and brands of lubricants recommended for your car by Toyota are shown on the next page.

RECOMMENDED PETROLEUM PRODUCTS

LUBRICANT & CLASSIFICATION		PRODUCTS											
		AGIP	BP	CALTEX	CASTROL	CHEVRON	ESSO	MOBIL	SHELL	SUN	TEXACO	TOTAL	VALVOLINE
Engine Oil	API SD or SE	F1 Woom 10W/40, 20W/50 10W/20, 30 40, 50	BP Super Viscostatic 5W/20, 10W/30, 10W/40, 20W/50	Supreme Five Star Motor Oil 10W/30, 10W/40, 20W/40, 20W/50	Castrol GTX 20W/50	Chevron Custom Motor Oil 10W/40 Chevron Supreme Motor Oil 5W/30, 10W/30, 20W/40, 10W/40 Chevron Special Motor Oil 10W, 20W/20, 30, 40, 50	Eso Uniflo 5W/30, 10W/40 Eso lube DX-3 10W, 20W, 30, 40	Mobilul Super 5W/30, 10W/50, 20W/50 Mobilul Special 5W/20, 10W/30, 20W/40, 20W/50 Mobilul 5W/20, 10W, 20W/20, 20W/30, 30, 40, 50	Super Motor Oil 10W/50	Sunoco Special Motor Oil 5W/30, 10W/40, 20W/50 Sunoco Dynalube Motor Oil 10W/30, 20W/40 Sunoco Sunlube Motor Oil 10W, 20W/20, 30, 40, 50	Havoline Super Premium Motor Oil 5W/30, 10W/40, 20W/50 Havoline Motor Oil 10W, 20W/20, 30, 40, 50	Total GTS 10W/30, 10W/40, 20W/40, 20W/50 Total Super HD 10W, 20, 30, 40, 50 Antigrade GTX 10W/30, 10W/40, 20W/40, 20W/50	Valvoline XLD 10W/30, 10W/40, 20W/50 Valvoline High Per- formance Racing Oil 10W, 20, 30, 40, 50 All-Climate Motor Oil HDB 10W/30, 20W/40, 20W/50 Super HPO HDB 10W, 20W, 30, 40, 50
		F1 Rota Hypod 90	BP Gear Oil EP 90	Universal Thuban 90	Castrol Hypoy 90	Chevron Multi-service Gear Lubricant 90	Eso Gear Oil GP 90	Mobilube GX 90	Spirax 90	Sun Dual-purpose Gear Oil	Universal Gear Lubricant EP 90 90	Extreme Pressure 90	X 18 MD IGL-SI 80/90
Gear Oil (Differential)	API GL 5	F1 Rota MP/S 90	BP Hypogear Oil EP 80, 90	Multipurpose Thuban EP 80, 90	Castrol Hypoy B 80, 90	Chevron Universal Gear Lubricant 80, 90	Eso Gear Oil GX 80, 90	Mobilube HD 80, 80/90, 90	Spirax HD 90	Sunoco MP Gear Lubricant 80, 90	Multigear Lubricant EP 80, 90	Extreme Pressure Type B 80, 90	High Performance Gear Lubricant 80, 80/90, 90
Gear Oil Limited Slip Differential			BP Lmslip 90-1	3450 Gear Oil 90	Castrol Hypoy LS 90			Mobilube 46 90				3450 Gear Oil 90	
Automatic Transmission Fluid	ATF Type F		BP Autran B	Texmatic Type F	Castrol TGF	Chevron ATF Special	Glide	Mobil ATF 210	Donax T7	Sunoco Transmatic Fluid Ford Type	Texmatic Type F	ATF 33	ATF Type FA
Chassis Grease (Ball Joint)	NL G1 No. 1 or No. 2	F1 GR SM	BP Energrease L21M	Molytex Grease 2	Castrol MS3	Chevron Moly Grease 1 or 2	Beacon O2	Mobilgrease Special	Retinax AM	Sunoco Multi-duty Grease 1M3 or 2M3	Molytex Grease 2	Multis MS	Special Moly Grease
Wheel Bearing Grease	NLG1 No. 2	F1 Grease 30	BP Energrease L2	Marfak Multi- Purpose 2	Castrol LM	Chevron Multi- Motive Grease 2	Eso Multipurpose Grease	Mobilgrease MP or JL	Retinax A	Sunoco Prestige Grease 742EP	Marfak Multi-Purpose 2	Multis	Lithium No. 2
Brake Fluid	SAE 7DR-3 SAE J1703	F1 Brake Fluid Super HD	BP Disc Brake Fluid	Caltex Heavy Duty Brake Fluid	Castrol Giring Brake Fluid (Green)	Atlas Special Heavy Duty Brake Fluid 550	Eso Brake Fluid HD400... (Far East) Eso Brake Fluid ... (Europe)	Mobil Super Heavy Duty Brakes Fluid	Donax B	Sunoco Brake Fluid 550	Texaco Super Heavy Duty Motor Vehicle Brake Fluid	Brake Fluid	Brake Fluid
Anti-freeze	LLC Long Life Coolant	F1 Anti-freeze	BP Antifrost (LLC)	Startek Anti-freeze Coolant (LLC)	Castrol Anti-freeze	Atlas Perma-guard Anti-freeze & Coolant (LLC)	Eso Long Life Coolant... (Far East) (LLC) Eso Anti-freeze ... (Europe)	Mobil Permazone (LLC)	Shellzone (LLC)	Sunoco Multi-Season Anti-freeze	Texaco Anti-freeze Coolant (LLC)	Antigel (LLC)	Permanent Anti-freeze & Coolant (LLC)

The number given with oil is the SAE viscosity rating.

Use of proper viscosity oil is very important to give the best performance under driving conditions in your part of the country. For easy starting during the colder months, it is particularly important as the viscosity of oil affects the cranking speed.

When replenishing and changing lubricants for engine and differential, select those which have proper viscosity for the climate of the area where you drive your car by referring to the graph of proper oil viscosity shown below. Do not use SAE 5W-20 or thinner in sustained high-speed operation.

Lubricant Viscosity Recommendations

TEMP.		°C					
		-23	-12	0	10	32	
		°F					
		-10	10	32	50	90	
ENGINE OIL (SAE)	Single grade	5W	10W	20W	20	30	40
	Multi-grade	5W-20		10W-30			20W-40
DIFF. GEAR OIL (SAE)		80	90				

SERVICE DATA

Battery specific gravity	1.260 at 20°C (68°F)	
Fan belt deflection	8 to 12mm (0.3 to 0.5")	
Distributor: point pressure	500 to 700g (18 to 24oz)	
point gap	0.45mm (0.018")	
cam closing angle	50 to 54°	
condenser capacity	0.20 to 0.24 micro-farad	
Spark plug gap:	2T & 2T-B	0.8mm (0.031")
	2T-G	1.0mm (0.039")
Firing order	1 - 3 - 4 - 2	
Valve clearance:	Hot	
	2T & 2T-B (IN)	0.20mm (0.008")
		0.33mm (0.013")
	(EX)	0.18mm (0.007")
0.30mm (0.012")		
2T-G (IN)	—	0.29 to 0.34mm (0.011 to 0.013")
	(EX)	—
Ignition timing/idle speed:	BTDC 10°/600 to 700 rpm	
	BTDC 12°/700 to 800rpm	
	BTDC 16°/750 to 850 rpm	
Manifold vacuum at idle speed:	430mmHg (16.9 inHg) or more	
	400mmHg (15.7 inHg) or more	
Compression pressure at 250 rpm:	12.0kg/cm ² (170 psi) or more	
	12.8kg/cm ² (182 psi) or more	
	13.0kg/cm ² (185 psi) or more	
Compression pressure limit:	9.0kg/cm ² (128 psi)	
	10.0kg/cm ² (142 psi)	
Variation between cylinders	Less than 1kg/cm ² (14 psi)	
Brake pedal pad to floorboard clearance when depressed	55mm (2.2") or more	
Parking brake lever travel	6 to 12 clicks	
Clutch pedal free play	25 to 45mm (1.0 to 1.8")	
Steering wheel free play	0 to 20mm (0.8")	
Front wheel alignment:	Unloaded	
Side slip	0 to 3mm (0.12") per 1m (3.3ft)	
Toe-in	5 to 7mm (0.20 to 0.27")	
Camber	30' to 1°30'	
Caster	30' to 1°30'	
Steering axis indication	7°30'	

FUSE SPECIFICATIONS

Fuse holder	Amperage	What circuit each fuse controls
TALL	15	Parking lights, Tail lights, License plate lights, Glove box light, Instrument panel lights & Switch knob illumination lights
HORN	20	Horn, Stop lights & Hazard warning lights
LIGHTER	20	Cigarette lighter, Clock, Door courtesy lights & Interior light
RADIO	15	Radio & Stereo
HEATER	20	Brake system warning light (for car w/ dual circuit brake system), Rear window defogger, Back-up lights, Heater blower, Gauges & Parking brake warning light
TURN	15	Turn signal lights & Voltage regulator IG terminal
IG COIL	15	Ignition coil positive terminal
WIPER	20	Windshield wiper & Washer

CAPACITIES

		Liters	US	Imp.
Fuel tank		50	13 gal.	11 gal.
Engine coolant		LT & ST	6.5	6.9 qt. 5.7 qt.
		GT	7.4	7.8 qt. 6.5 qt.
Engine oil	Crankcase only	LT & ST	2.8	3.0 qt. 2.5 qt.
		GT	2.9	3.1 qt. 2.6 qt.
	Total	LT & ST	3.7	3.9 qt. 3.3 qt.
		GT	3.8	4.0 qt. 3.3 qt.
Manual transmission oil		1.5	1.6 qt.	1.4 qt.
Automatic transmission fluid		7.0	7.4 qt.	6.2 qt.
Differential oil		Standard	1.0	1.06 qt. 0.88 qt.
		Limited slip diff.	1.1	1.17 qt. 0.97 qt.
Steering gear box oil		0.25	0.5 pt.	0.5 pt.

GENERAL SPECIFICATIONS

	LT			ST		GT
DIMENSIONS mm (in)						
Wheel base	2,425 (95.5)			same		same
Tread: front	1,280 (50.4)			same		same
rear	1,285 (50.6)			same		same
Overall length	4,165 (164.0)			same		same
Overall width	1,600 (63.0)			same		same
Overall height	1,310 (51.6)			same		same
Ground clearance	175 (6.9)			same		same
TIRE SIZE Standard	6.45S-13 4PR			same		165HR 13
Option	165SR 13			same		—
	165HR 13			same		—
ENGINE Model	TOYOTA 2T			TOYOTA 2T-B		TOYOTA 2T-G
Type	4-cylinder in line, 4-cycle OHV w/ down-draft 2 barrel type single carburetor			same w/ down-draft 2 barrel type twin carburetor		4-cylinder in line, 4-cycle DOHC w/ side-draft 2 barrel type SOLEX carburetor
Bore & Stroke	85 x 70mm (3.35 x 2.75 in)			same		same
Piston displacement	1,588cc (96.9 cu.in.)			same		same
Compression ratio	8.5 to 1			9.4 to 1		9.8 to 1
Maximum	SAE 102 HP at 6,000 rpm			SAE 113 HP at 6,000 rpm		SAE 124 HP at 6,400 rpm
Maximum torque	SAE 14.0m·kg (101 ft·lb) at 3,800 rpm			SAE 15.1m·kg (109 ft·lb) at 4,200 rpm		SAE 15.6m·kg (113 ft·lb) at 5,200 rpm
ELECTRICAL SYSTEM						
Battery: Standard	12-volt	35 A.H.		same		same
Option	12-volt	40 A.H., 60 A.H.		same		same
Starter	12-volt	0.8 kw		same		same
Alternator	12-volt	0.48 kw		same		same
MANUAL TRANSMISSION						
Type	4-speed or 5-speed floor shift, all forward gears synchromesh			same		5-speed floor shift, all forward gears synchromesh
Gear ratio: 1st	3.587	3.587		same		3.587
2nd	2.022	2.022		same		2.022
3rd	1.384	1.384		same		1.384
4th	1.000	1.000		same		1.000
5th	—	0.861		same		0.861
Reverse	3.484	3.489		same		3.484
AUTOMATIC TRANSMISSION						
Type	Automatic 3-speed floor shift.			—		—
Gear ratio: Low	2.400			—		—
2nd	1.479			—		—
Drive	1.000			—		—
Reverse	1.920			—		—
DIFFERENTIAL GEAR						
Reduction ratio	4-speed	5-speed	Automatic	4-speed	5-speed	5-speed
	3.900	4.111	4.111	3.900	4.111	4.111
	4.111 (OPT)		4.300 (OPT)	4.111 (OPT)		

ENGINE SERIAL NUMBER

The engine serial number is stamped on the right side of the engine block, behind the alternator.

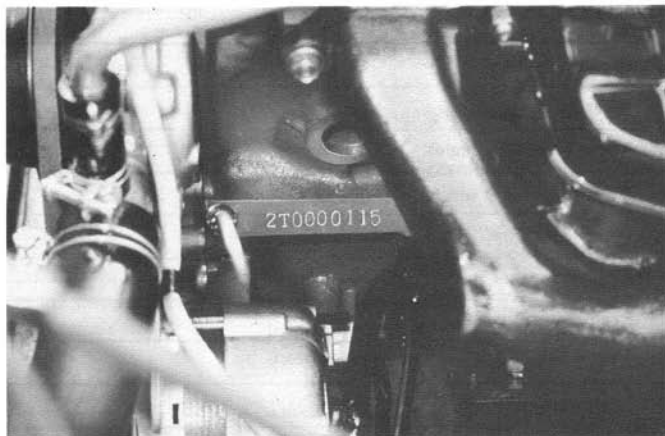

VEHICLE SERIAL NUMBER

The vehicle serial number is stamped on the right side of the hood lock on the fire wall in the engine compartment.

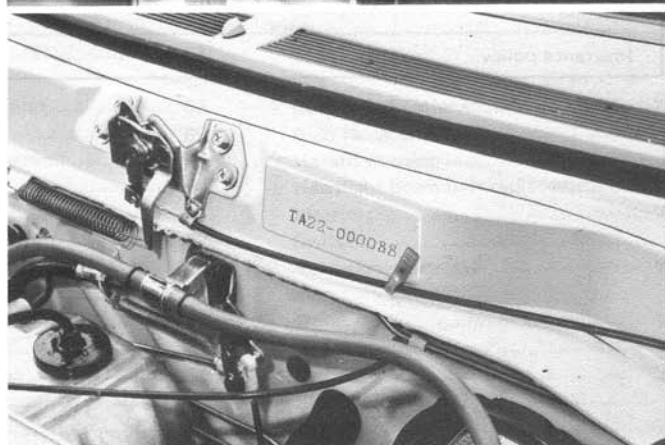

IDENTIFICATION

Owner's name	
Address	TEL.
Name of selling dealer	
Address	TEL.
License number	
Engine number	
Frame number	
Key number	
Insurance company	
Address	TEL.
Insurance policy	

Prepared by

TOYOTA MOTOR SALES CO., LTD.

Export - Technical Department, Haruhi Plant

INDEX

Air cleaner	58	Differential oil	64	Fusible link.....	70
Air conditioner.....	27	Dimmer switch	6	Glove box.....	19
Ammeter	10	Door locks.....	13	General specifications.....	80
Ashtray.....	22	Engine		Hazard warning light switch.....	8
Automatic transmission		Coolant.....	53	Headlight	
Fluid level check.....	62	Coolant temperature gauge.....	10	Beam unit replacement.....	72
Selector lever.....	37	Hood	30	High beam indicator light	12
Ball joint.....	64	Maintenance	51	Heater.....	25
Battery	69	Overheating	44	Hood, Engine.....	30
Boost ventilation	25	Serial number	81	Ignition switch.....	4
Brakes		Starting.....	34, 43	Inflation pressure, Tire.....	66
Booster	61	Tachometer	9	Interior light.....	22
Fluid level.....	59	Engine lubricant		Jack	31
Parking brake.....	18, 60	Dipstick	51	Jump starting.....	43
Pedal.....	60	Filter	53	Keys.....	4
Warning light.....	12	Viscosity.....	78	Lights	
Bulb specifications.....	74	Fan belt.....	57	Bulb specifications.....	74
Capacities	79	Fluid level		Bulb replacement.....	74
Changing a flat tire	66	Automatic transmission.....	63	Hazard warning.....	8
Charge warning light.....	11	Battery	69	Headlight beam unit replacement	72
Cigarette lighter.....	22	Brake and clutch reservoir	59	Interior	22
Clock	23	Differential oil.....	64	Switch	5
Clutch fluid	59	Engine oil	51	Turn signal indicator.....	11
Clutch pedal	61	Manual transmission	62	Locks	
Coolant temperature gauge.....	10	Radiator coolant	53	Door	13
Courtesy light.....	32	Fuel		Glove box.....	19
Defogger	23	Gauge	10	Hood	30
		Filler cap	32	Steering column.....	4
		Recommendation	32, 76	Lubricant.....	76
		Fuse block	71		
		Fuse specification	72, 79		

Capacities.....	79	Specifications.....	76	Windshield	
Viscosity.....	78	Speedometer.....	9	Defrosting (Defogging).....	26
Luggage compartment.....	30	Starting techniques.....	34	Washer switch.....	7
		Starting the engine.....	34	Wiper switch.....	7
		Emergency starting.....	43		
Maintenance schedule.....	48	Steering column lock.....	4		
Manual transmission.....	36	Steering gear oil.....	62		
		Steering wheel.....	62		
Oil		Stereo tape player.....	21		
Filter.....	53				
Pressure gauge.....	10	Tachometer.....	9		
Pressure warning light.....	11	Tire.....	65		
Operating the transmission		Tire inflation pressure.....	66		
Manual transmission.....	36	Tire replacement.....	66		
Automatic transmission.....	37	Tire size.....	66, 80		
Transmission.....		Tools.....	31		
		Towing.....	46		
Parking your car.....	41	Transmission			
Parking brake.....	18, 60	Manual transmission.....	36		
		Automatic transmission.....	37		
Radio.....	20	Transmission oil.....	62		
Rear view mirror.....	19	Trunk.....	30		
Rear window defogger.....	23	Turn signal indicator light.....	11		
Recommended petroleum products.....	76	Turn signal switch.....	6		
Replacing headlight beam unit.....	72				
Replacing light bulbs.....	74	Vehicle serial number.....	81		
		Ventilation louvers.....	24		
Seat belts.....	15				
Seat belt inspection.....	68	Warning lights			
Seats.....	14, 68	Brake.....	12		
Serial numbers.....	81	Oil pressure.....	11		
Service data.....	78	Washer tank.....	8		
Spare tire.....	31				
Spark plug.....	56				

TOYOTA SERVICE RECORD

This page is provided for your convenience. Please maintain your Toyota's Service Record in the spaces provided.

km (miles)

1 month	1,000 (600)	Owner Name _____ Date _____ Actual Mileage _____ Dealer Code _____ Authorized Dealer Signature _____	27 months	45,000 (27,000)	Owner Name _____ Date _____ Actual Mileage _____ Dealer Code _____ Authorized Dealer Signature _____
3 months	5,000 (3,000)	Owner Name _____ Date _____ Actual Mileage _____ Dealer Code _____ Authorized Dealer Signature _____	30 months	50,000 (30,000)	Owner Name _____ Date _____ Actual Mileage _____ Dealer Code _____ Authorized Dealer Signature _____
6 months	10,000 (6,000)	Owner Name _____ Date _____ Actual Mileage _____ Dealer Code _____ Authorized Dealer Signature _____	33 months	55,000 (33,000)	Owner Name _____ Date _____ Actual Mileage _____ Dealer Code _____ Authorized Dealer Signature _____
9 months	15,000 (9,000)	Owner Name _____ Date _____ Actual Mileage _____ Dealer Code _____ Authorized Dealer Signature _____	36 months	60,000 (36,000)	Owner Name _____ Date _____ Actual Mileage _____ Dealer Code _____ Authorized Dealer Signature _____
12 months	20,000 (12,000)	Owner Name _____ Date _____ Actual Mileage _____ Dealer Code _____ Authorized Dealer Signature _____	39 months	65,000 (39,000)	Owner Name _____ Date _____ Actual Mileage _____ Dealer Code _____ Authorized Dealer Signature _____
15 months	25,000 (15,000)	Owner Name _____ Date _____ Actual Mileage _____ Dealer Code _____ Authorized Dealer Signature _____	42 months	70,000 (42,000)	Owner Name _____ Date _____ Actual Mileage _____ Dealer Code _____ Authorized Dealer Signature _____
18 months	30,000 (18,000)	Owner Name _____ Date _____ Actual Mileage _____ Dealer Code _____ Authorized Dealer Signature _____	45 months	75,000 (45,000)	Owner Name _____ Date _____ Actual Mileage _____ Dealer Code _____ Authorized Dealer Signature _____
21 months	35,000 (21,000)	Owner Name _____ Date _____ Actual Mileage _____ Dealer Code _____ Authorized Dealer Signature _____	48 months	80,000 (48,000)	Owner Name _____ Date _____ Actual Mileage _____ Dealer Code _____ Authorized Dealer Signature _____
24 months	40,000 (24,000)	Owner Name _____ Date _____ Actual Mileage _____ Dealer Code _____ Authorized Dealer Signature _____	51 months	85,000 (51,000)	Owner Name _____ Date _____ Actual Mileage _____ Dealer Code _____ Authorized Dealer Signature _____



TOYOTA MOTOR SALES CO., LTD.

No. 9664E PRINTED IN JAPAN © 28